



**DC POWER SUPPLY  
BENCH SERIES  
MODEL 6216A**

OPERATING AND SERVICE MANUAL

FOR SERIALS 8M1601 - UP\*

\*For Serials Above 8M1601  
Check for inclusion  
change page.

\*For Serials Below 8M1601  
Refer to Appendix A.

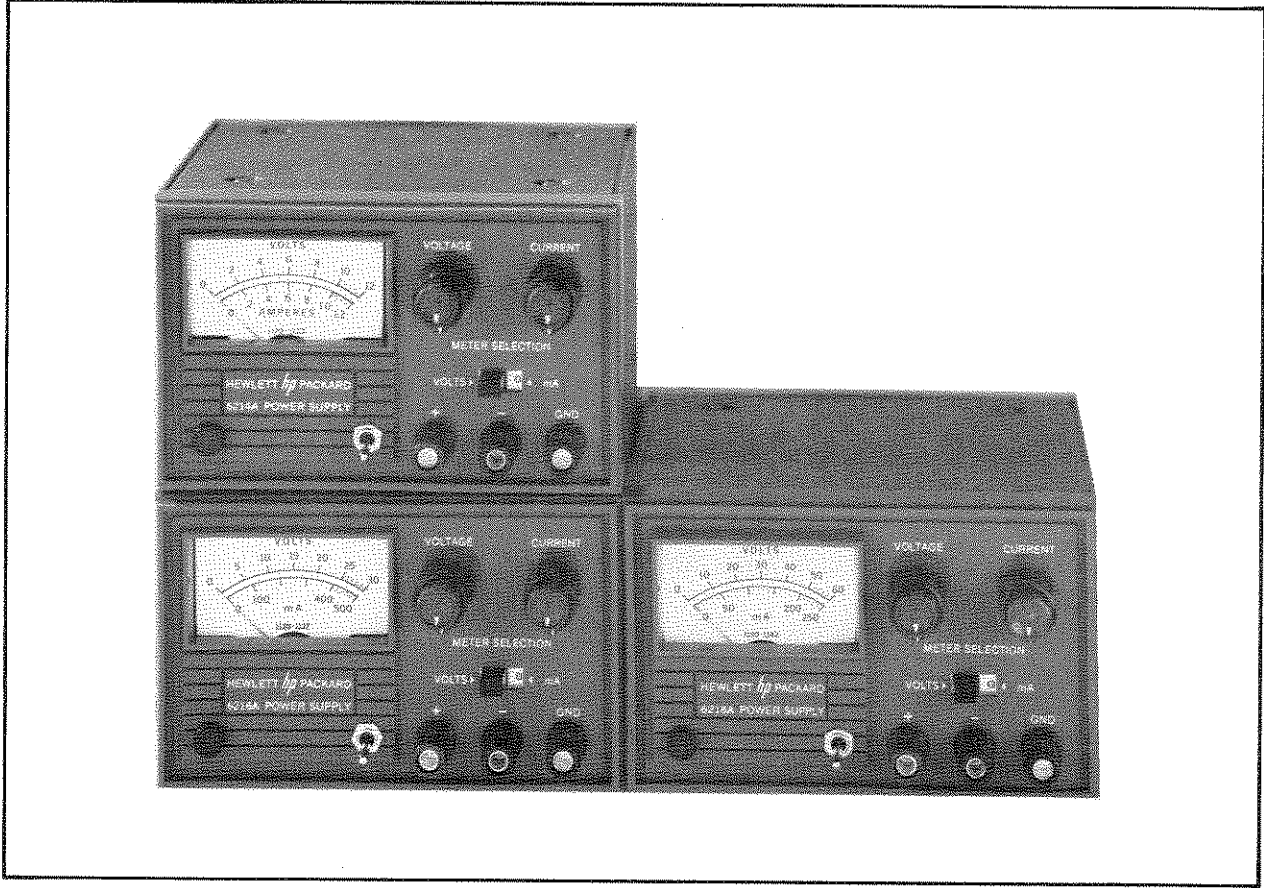

Figure 1-1. DC Power Supplies, Models 6214A, 6216A and 6218A

## SECTION I GENERAL INFORMATION

### 1-1 DESCRIPTION

1-2 This power supply, Figure 1-1, is completely transistorized and suitable for either bench or relay rack operation. It is a compact, well-regulated, Constant Voltage/Constant Current supply that will furnish full rated output voltage at the maximum rated output current or can be continuously adjusted throughout the output range. The front panel CURRENT control can be used to establish the output current limit (overload or short circuit) when the supply is used as a constant voltage source and the VOLTAGE controls can be used to establish the voltage limit (ceiling) when the supply is used as a constant current source. The supply will automatically crossover from constant voltage to constant current operation and vice versa if the output current or voltage exceeds these preset limits.

1-3 Either the positive or negative output terminal may be grounded or the power supply can be operated floating at up to a maximum of 300 Volts off ground.

1-4 A single meter is used to measure either output voltage or output current in Volts or mA. The voltage or current range is selected by the METER SELECTION switch on the front panel.

### 1-5 SPECIFICATIONS

1-6 Detailed specifications for the power supply are given in Table 1-1.

### 1-7 OPTIONS

1-8 Options are factory modifications of a standard instrument that are requested by the customer. The following options are available for the instrument covered by this manual. Where necessary, detailed coverage of the options is included throughout the manual.

<u>Option No.</u>	<u>Description</u>
28	<u>230V, 50-400Hz, Single-Phase Output.</u> Factory modification consists

of reconnecting the input transformer for 230Vac operation. Refer to Section II for further details.

### 1-9 ACCESSORIES

1-10 The accessories listed in the following chart may be ordered with the power supply or separately from your local Hewlett-Packard field sales office (refer to list at rear of manual for addresses).

<u>Part No.</u>	<u>Description</u>
14521A	3½" High Rack Kit for mounting up to three BENCH supplies. (Refer to Section II for details.)

### 1-11 INSTRUMENT AND SERVICE MANUAL IDENTIFICATION

1-12 Hewlett-Packard power supplies are identified by a three-part serial number tag. The first part is the power supply model number. The second part is the serial number prefix, which consists of a number-letter combination that denotes the date of a significant design change. The number designates the year, and the letter A through M designates the month, January through December, respectively, with I omitted. The third part is the power supply serial number; a different sequential number is assigned to each power supply.

1-13 If the serial number on your instrument does not agree with those on the title page of the manual, Change sheets supplied with the manual or Manual Backdating Changes in Appendix A define the differences between your instrument and the instrument described by this manual.

### 1-14 ORDERING ADDITIONAL MANUALS

1-15 One manual is shipped with each power supply. Additional manuals may be purchased from your local Hewlett-Packard field office (see list at rear of this manual for addresses). Specify the model number, serial number prefix, and  stock number provided on the title page.

Table 1-1. Specifications

<p><b>INPUT:</b> 115Vac, <math>\pm 10\%</math>, 50-400Hz, 0.25A, 26W.</p> <p><b>OUTPUT:</b> 0-25Vdc, 0-400mA.</p> <p><b>LOAD REGULATION:</b> <u>Constant Voltage</u> - Less than 4 millivolts for a load current change equal to the current rating of the supply. <u>Constant Current</u> - Less than 500<math>\mu</math>A for a load voltage change equal to the voltage rating of the supply.</p> <p><b>LINE REGULATION:</b> <u>Constant Voltage</u> - Less than 4 millivolts for a <math>\pm 10\%</math> change in the nominal line voltage at any output voltage and current within rating. <u>Constant Current</u> - Less than 500<math>\mu</math>A for a <math>\pm 10\%</math> change in the nominal line voltage at any output voltage and current within rating.</p> <p><b>RIPPLE AND NOISE</b> <u>Constant Voltage</u> - Less than 200<math>\mu</math>Vrms/1mV p-p (dc to 20MHz). <u>Constant Current</u> - Less than 150<math>\mu</math>Arms/500<math>\mu</math>A p-p (dc to 20MHz).</p> <p><b>TEMPERATURE RANGES:</b> Operating: 0 to 55<math>^{\circ}</math>C. Storage: -40<math>^{\circ}</math>C to +75<math>^{\circ}</math>C.</p> <p><b>TEMPERATURE COEFFICIENT:</b> <u>Constant Voltage</u> - Less than 0.02% + 1mV output change per degree centigrade change in ambient following 30 minutes warm-up. <u>Constant Current</u> - Less than 2mA per <math>^{\circ}</math>C output change per degree centigrade change in ambient following 30 minutes warm-up.</p> <p><b>STABILITY:</b> <u>Constant Voltage</u> - Less than 0.1% + 5mV total drift for 8 hours following 30 minutes warm-up at constant ambient, constant line voltage, and constant load. <u>Constant Current</u> - Less than 5mA total drift for 8 hours following 30 minutes warm-up at constant ambient, constant line voltage, and constant load.</p> <p><b>INTERNAL IMPEDANCE AS A CONSTANT VOLTAGE SOURCE:</b> Less than 0.03 ohm from dc to 1kHz. Less than 0.5 ohm from 1kHz to 100kHz.</p>	<p>Less than 3 ohms from 100kHz to 1MHz.</p> <p><b>TRANSIENT RECOVERY TIME:</b> Less than 50<math>\mu</math>sec for output voltage recovery in constant voltage operation to within 15mV of the nominal output voltage following a change in output current equal to the current rating of the supply.</p> <p><b>OVERLOAD PROTECTION:</b> A fixed current limiting circuit protects the power supply for all overloads including a direct short circuit placed across the output terminals in constant voltage operation.</p> <p><b>METER:</b> The front panel meter can be used as either a 0-30V voltmeter or as a 0-500mA ammeter.</p> <p><b>OUTPUT CONTROLS:</b> Concentric coarse and fine voltage controls and, concentric coarse and fine current controls set desired output voltage/current. Meter switch selects voltage or current.</p> <p><b>OUTPUT TERMINALS:</b> Three "five-way" output terminals are provided on the front panel. They are isolated from the chassis and either the positive or negative terminal may be connected to the chassis through a separate ground terminal.</p> <p><b>COOLING:</b> Convection cooling is employed. The supply has no moving parts.</p> <p><b>SIZE:</b> 3<math>\frac{1}{4}</math>"/8, 26cm H x 5<math>\frac{1}{4}</math>"/13, 34cm W x 7"/17, 78cm D. Using a Rack Mounting Kit, three units can be mounted side by side in a standard 19" relay rack.</p> <p><b>WEIGHT:</b> 4.75 lbs./2, 2 kg. net, 6.75 lbs./3, 1 kg. shipping.</p> <p><b>FINISH:</b> Dark gray.</p> <p><b>POWER CORD:</b> A 3-wire, 5-foot (1,52cm) power cord is provided with each unit.</p>
--	--

## SECTION II INSTALLATION

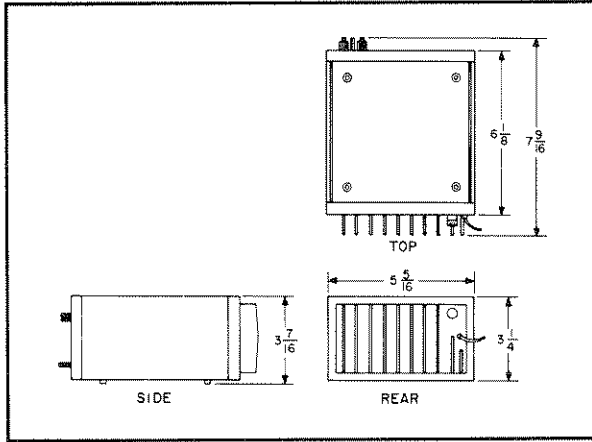

Figure 2-1. Outline Diagram

### 2-1 INITIAL INSPECTION

2-2 Before shipment, this instrument was inspected and found to be free of mechanical and electrical defects. As soon as the instrument is unpacked, inspect for any damage that may have occurred in transit. Save all packing materials until the inspection is completed. If damage is found, proceed as described in the Claim for Damage in Shipment section of the warranty page at the rear of this manual.

### 2-3 MECHANICAL CHECK

2-4 This check should confirm that there are no broken knobs or connectors, that the cabinet and

panel surfaces are free of dents and scratches, and that the meter is not scratched or cracked.

### 2-5 ELECTRICAL CHECK

2-6 The instrument should be checked against its electrical specifications. Section V includes an "in-cabinet" performance check to verify proper instrument operation.

### 2-7 INSTALLATION DATA

2-8 The instrument is shipped ready for bench operation. It is necessary only to connect the instrument to a source of power and it is ready for operation.

### 2-9 LOCATION

2-10 This instrument is air cooled. Sufficient space should be allotted so that a free flow of cooling air can reach the rear of the instrument when it is in operation. It should be used in an area where the ambient temperature does not exceed 55°C.

### 2-11 OUTLINE DIAGRAM

2-12 Figure 2-1 illustrates the outline shape and dimensions of Models 6213A through 6218A.

### 2-13 RACK MOUNTING

2-14 This instrument may be rack mounted separately or with a maximum of two other BENCH Series supplies as shown in Figure 2-2. The

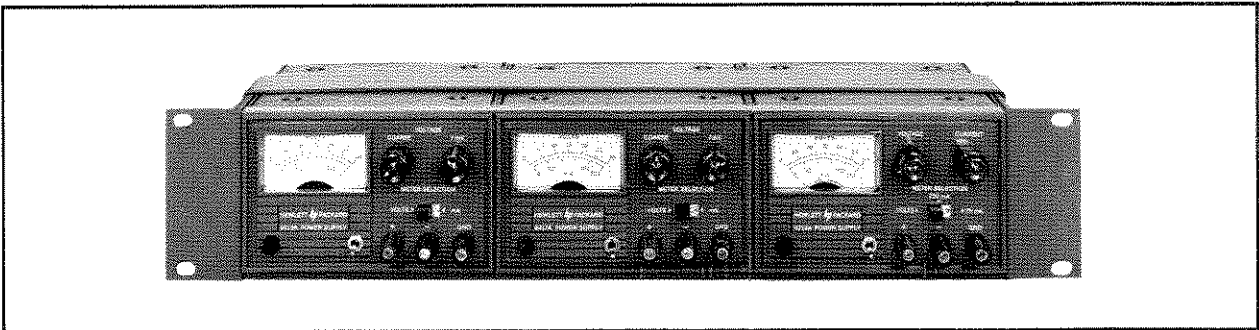

Figure 2-2. Rack Kit with Three BENCH Supplies

units are placed in the Rack Mounting Frame. The Rack Mounting Frame is then fastened to the rack frame.

## 2-15 INPUT POWER REQUIREMENTS

2-16 This power supply may be operated continuously from either a nominal 115 Volt or 230 Volt 50-400Hz power source. The unit as shipped from the factory, is wired for 115 Volt operation. The input power required when operated from a 115 Volt power source at full load is:

Model	Input Current	Input Power
6213A and 6214A	0.29A	28W
6215A and 6217A	0.25A	26W
6216A and 6218A	0.25A	26W

## 2-17 CONNECTIONS FOR 230 VOLT OPERATION (Figure 2-3)

2-18 Normally, the two primary windings of the input transformer are connected in parallel for operation from 115 Volt source. To convert the power supply to operation from a 230 Volt source, the power transformer windings are connected in series as follows:

- a. Unplug the line cord and remove the top cover as described in Paragraph 5-3.
- b. Remove the jumpers between taps 4-2 and 3-1. Solder a jumper between taps 3-2 on the input power transformer T1, see Figure 2-3.
- c. Replace existing fuse with a 0.5 Ampere, 230 Volt fuse.
- d. Replace existing line cord plug with a standard 230 Volt plug.

## 2-19 POWER CABLE

2-20 To protect operating personnel, the National Electrical Manufacturers Association (NEMA) recommends that the instrument panel and cabinet be grounded. This instrument is equipped with a three conductor power cable. The third conductor is the ground conductor and when the cable is plugged

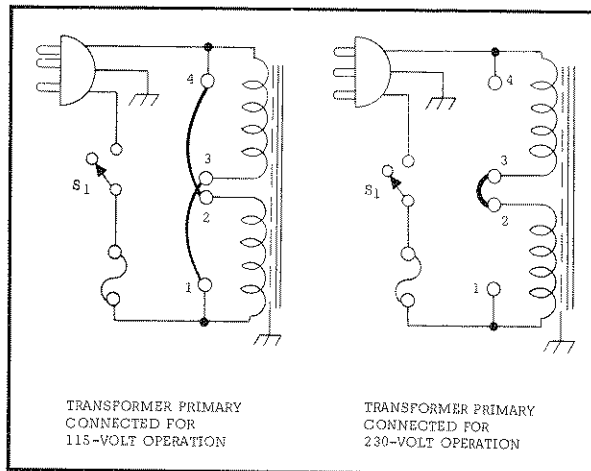

Figure 2-3. Input Power Transformer, Connections

into an appropriate receptacle, the instrument is grounded. The offset pin on the power cable three-prong connector is the ground connection.

2-21 To preserve the protection feature when operating the instrument from a two-contact outlet, use a three-prong to two-prong adapter and connect the green lead on the adapter to ground.

## 2-22 REPACKAGING FOR SHIPMENT

2-23 To insure safe shipment of the instrument, it is recommended that the package designed for the instrument be used. The original packaging material is reusable. If it is not available, contact your local Hewlett-Packard field office to obtain the materials. This office will also furnish the address of the nearest service office to which the instrument can be shipped. Be sure to attach a tag to the instrument which specifies the owner, model number, full serial number, and service required, or a brief description of the trouble.

## SECTION III OPERATING INSTRUCTIONS

### 3-1 TURN-ON CHECKOUT PROCEDURE

3-2 The following checkout procedure describes the use of the front panel controls and indicators illustrated in Figure 3-1 and ensures that the supply is operational:

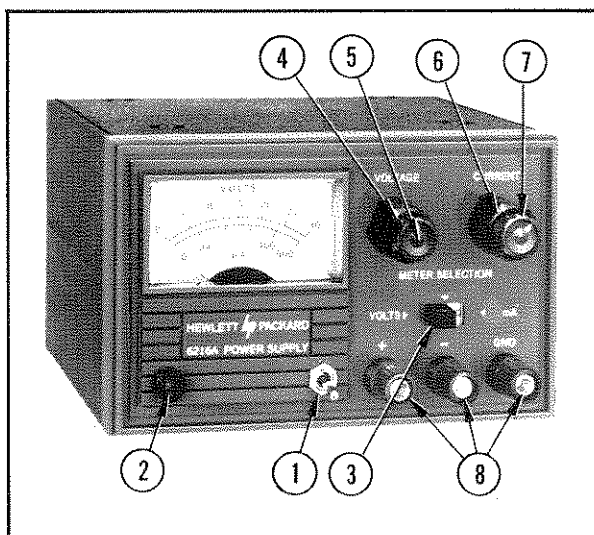

Figure 3-1. Front Panel Controls and Indicators

- a. Set AC toggle switch (1) upward to on position; indicator (2) should light.
- b. Set METER SELECTION switch (3) to VOLTS position.
- c. Turn coarse (4) and fine (5) VOLTAGE controls fully ccw to ensure that output decreases to 0V, then turn the VOLTAGE controls fully cw to ensure that output voltage increases to the maximum rated output voltage.
- d. Set METER SELECTION switch (3) to mA position and short circuit (+) and (-) output terminals.
- e. Turn coarse (6) and fine (7) CURRENT controls fully ccw and then fully cw to ensure that the output current reaches zero and maximum rated output.
- f. Remove short and connect load to output terminals.

### 3-3 OPERATION

3-4 The power supply can be operated as a single unit (normal operation), in parallel, or in series. The output of the supply can be floated up to 300 Volts off ground.

#### 3-5 CONSTANT VOLTAGE

3-6 To select a constant voltage output, proceed as follows:

- a. Turn-on power supply and adjust VOLTAGE controls for desired output voltage (output terminals open).
- b. Short output terminals and adjust CURRENT controls for maximum output current allowable (current limit), as determined by load conditions. If a load change causes the current limit to be exceeded, the power supply will automatically crossover to constant current output at the preset current limit and the output voltage will drop proportionately. In setting the current limit, allowance must be made for high peak current which can cause unwanted cross-over. (Refer to Paragraph 3-20).

#### 3-7 CONSTANT CURRENT

3-8 To select a constant current output, proceed as follows:

- a. Short output terminals and adjust CURRENT controls for desired output current.
- b. Open output terminals and adjust VOLTAGE controls for maximum output voltage allowable (voltage limit), as determined by load conditions. If a load change causes the voltage limit to be exceeded, the power supply will automatically crossover to constant voltage output at the preset voltage limit and the output current will drop proportionately. In setting the voltage limit, allowance must be made for high peak voltages which can cause unwanted crossover. (Refer to Paragraph 3-20).

3-9 Each load should be connected to the power supply output terminals using separate pairs of connecting wires. This will minimize mutual coupling effects between loads and will retain full advantage of the low output impedance of the power supply. Each pair of connecting wires should be as short as possible and twisted or shielded to re-

duce noise pickup. (If shield is used, connect one end to power supply ground terminal and leave the other end unconnected.)

3-10 If load considerations require that the output power distribution terminals be remotely located from the power supply, then the power supply output terminals should be connected to the remote distribution terminals via a pair of twisted or shielded wires and each load separately connected to the remote distribution terminals.

### 3-11 OPERATION OF SUPPLY BEYOND RATED OUTPUT

3-12 The shaded area on the front panel meter face indicates the amount of output voltage or current that is available in excess of the normal rated output. Although the supply can be operated in this shaded region without being damaged, it cannot be guaranteed to meet all of its performance specifications. However, if the line voltage is maintained above 115 Vac, the supply will probably operate within its specifications.

## 3-13 OPTIONAL OPERATING MODES

### 3-14 SERIES OPERATION

3-15 Normal Series Connections. Two or more power supplies can be operated in series to obtain a higher voltage than that available from a single supply. When this connection is used, the output voltage is the sum of the voltages of the individual supplies. Each of the individual supplies must be adjusted in order to obtain the total output voltage. The power supply contains a protective diode connected internally across the output which protects the supply if one power supply is turned off while its series partner(s) is on.

### 3-16 PARALLEL OPERATION

3-17 Two or more power supplies can be connected in parallel to obtain a total output current greater than that available from one power supply. The total output current is the sum of the output currents of the individual power supplies. The output CURRENT controls of each power supply can be separately set. The output voltage controls of one power supply should be set to the desired output voltage; the other power supply should be set for a slightly larger output voltage. The supply set to the lower output voltage will act as a constant voltage source; the supply set to the higher output will act as a current limit source, dropping its output voltage until it equals that of the other supply. The constant voltage source will deliver only that fraction of its total rated output current which is necessary to fulfill the total current demand.

## 3-18 SPECIAL OPERATING CONSIDERATIONS

### 3-19 PULSE LOADING

3-20 The power supply will automatically cross over from constant-voltage to constant-current operation in response to an increase (over the preset limit) in the output current. Although the preset limit may be set higher than the average output current, high peak currents (as occur in pulse loading) may exceed the preset current limit and cause crossover to occur. If this crossover limiting is not desired, set the preset limit for the peak requirement and not the average.

### 3-21 OUTPUT CAPACITANCE

3-22 An internal capacitor, across the output terminals of the power supply, helps to supply high-current pulses of short duration during constant voltage operation. Any capacitance added externally will improve the pulse current capability, but will decrease the safety provided by the current limiting circuit. A high-current pulse may damage load components before the average output current is large enough to cause the current limiting circuit to operate.

### 3-23 REVERSE CURRENT LOADING

3-24 Active loads connected to the power supply may actually deliver a reverse current to the power supply during a portion of its operating cycle. An external source cannot be allowed to pump current into the supply without loss of regulation and possible damage to the output capacitor. To avoid these effects, it is necessary to preload the supply with a dummy load resistor so that the power supply delivers current through the entire operating cycle of the load device.

3-25 Reverse Voltage Protection. A diode is connected across the output terminals with reverse polarity. This diode protects the output electrolytic capacitors and the series regulator transistors from the effects of a reverse voltage applied across the output terminals. For example, in series operation of two supplies, if the AC is removed from one supply, the diode prevents damage to the unenergized supply which would otherwise result from a reverse polarity voltage.

3-26 Since series regulator transistors or driver transistors cannot withstand reverse voltage, another diode is connected across the series transistor. This diode protects the series transistors in parallel or Auto-Parallel operation if one supply of the parallel combination is turned on before the other.





detected in the constant voltage or constant current input circuit, amplified by the mixer and error amplifiers, and applied to the series regulator in the correct phase and amplitude to counteract the change in output voltage or current.

4-5 Two input amplifiers are included in a CV/CC supply, one for controlling output voltage, the other for controlling output current. Since the constant voltage amplifier tends to achieve zero output impedance and alters the output current whenever the load resistance changes, while the constant current comparison amplifier causes the output impedance to be infinite and changes the output voltage in response to any load resistance change, it is obvious that the two comparison amplifiers cannot operate simultaneously. For any given value of load resistance, the power supply must act either as a constant voltage source or as a constant current source—it cannot be both; transfer between these two modes is accomplished at a value of load resistance equal to the ratio of the output voltage control setting to the output current control setting.

4-6 Figure 4-2 shows the output characteristic of a CV/CC power supply. With no load attached ( $R_L = \infty$ ),  $I_{OUT} = 0$ , and  $E_{OUT} = E_S$ , the front panel voltage control setting. When a load resistance is applied to the output terminals of the power supply, the output current increases, while the output voltage remains constant; point D thus represents a typical constant voltage operating

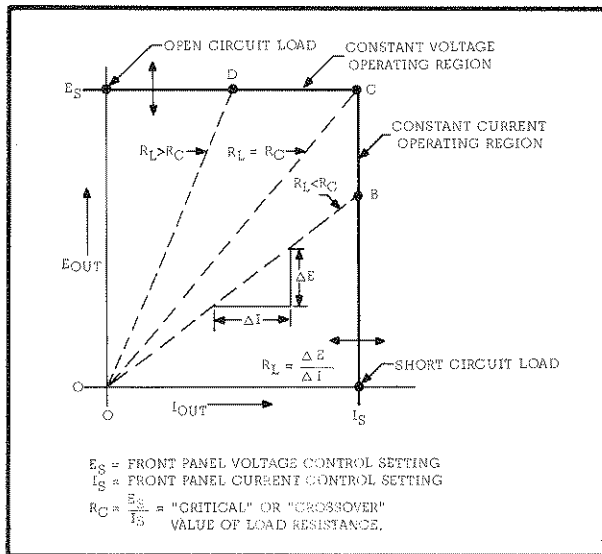

Figure 4-2. Operating Locus of a CV/CC Power Supply

point. Further decreases in load resistance are accompanied by further increases in  $I_{OUT}$  with no change in the output voltage until the output current reaches  $I_S$ , a value equal to the front panel current control setting. At this point the supply automatically changes its mode of operation and becomes a constant current source; still further decreases in the value of load resistance are accompanied by a drop in the supply output voltage with no accompanying change in the output current value. Thus, point B represents a typical constant current operating point. Still further decreases in the load resistance result in output voltage decreases with no change in output current, until finally, with a short circuit across the output load terminals,  $I_{OUT} = I_S$  and  $E_{OUT} = 0$ .

4-7 By gradually changing the load resistance from a short circuit to an open circuit the operating locus of Figure 4-2 will be traversed in the opposite direction.

Full protection against any overload condition is inherent in the Constant Voltage/Constant Current design principle since no load condition can cause an output which lies outside the operating locus of Figure 4-2. Whether one is primarily concerned with constant voltage or constant current operation, the proper choice of  $E_S$  and  $I_S$  insures optimum protection for the load device as well as full protection for the power supply itself.

4-8 The line connecting the origin with any operating point of the locus of Figure 4-2 has a slope which is proportional to the value of load resistance connected to the output terminals of the supply. One can define a "critical" or "crossover" value of load resistance  $R_C = E_S/I_S$ ; adjustment of the front panel voltage and current controls permits this "crossover" resistance  $R_C$  to be set to any desired value from 0 to  $\infty$ . If  $R_L$  is greater than  $R_C$ , the supply is in constant voltage operation, while if  $R_L$  is less than  $R_C$ , the supply is in constant current operation.

4-9 The reference circuit provides stable reference voltages which are used by the constant voltage/current input circuits for comparison purposes. The meter circuit provides an indication of output voltage or current for both operating modes.

4-10 Diode CR14 is connected across the output terminals in reverse polarity. It protects the output electrolytic capacitor and the series regulator transistor from the effects of a reverse voltage applied across the output terminals. For example, in series operation of two supplies, if the AC is removed from one supply, the diode prevents damage to the unenergized supply.

#### 4-11 DETAILED CIRCUIT ANALYSIS (Refer to Figures 7-1 and 7-2, Schematic Diagram)

##### 4-12 FEEDBACK LOOP

4-13 The feedback loop functions continuously to keep the output voltage constant during constant voltage operation, and the output current constant during constant current operation. For purposes of this discussion, assume that the unit is in constant voltage operation and that the programming resistors R10A and B have been adjusted so that the supply is yielding the desired output voltage. Further assume that the output voltage instantaneously rises (goes positive) due to a variation in the external load circuit.

4-14 Note that the change may be in the form of a slow rise in the output voltage or a positive going AC signal. An AC signal is coupled to Q1 through capacitor C1 and a DC voltage is coupled to Q1 through R10.

4-15 The rise in output voltage causes the voltage at the base of Q1 to decrease (go negative). Q1 now decreases its conduction and its collector voltage rises. The positive going error voltage is amplified and inverted by Q4 and fed to the base of series transistor Q7 via emitter follower Q5. The negative going input causes Q7 to decrease its conduction so that it drops more of the line voltage, and reduces the output voltage to its original level.

4-16 If the external load resistance is decreased to a certain crossover point as discussed in Paragraph 4-6 the output current increases until transistor Q12 begins to conduct. During this time, the output voltage has also decreased to a level so that the base of Q1 is at a high positive potential. With Q1 in full conduction, its collector voltage decreases by the amount necessary to back bias OR gate diode CR5 and the supply is now in the constant current mode of operation. The operation of the feedback loop during the constant current operating mode is similar to that occurring during constant voltage operation except that the input to the constant current input amplifier is obtained from the current sampling resistor R33.

##### 4-17 SERIES REGULATOR

4-18 The series regulator consists of transistor stage Q7 (see schematic at rear of manual). The regulator serves as a series control element by altering its conduction so that the output voltage or current is kept constant. The conduction of the transistor is controlled by the feedback voltage obtained from the error amplifier. Diode CR7 protects the series transistor against reverse volt-

ages that could develop during parallel operation, if one supply is turned on before the other.

##### 4-19 CONSTANT VOLTAGE INPUT AMPLIFIER

4-20 This circuit consists of programming resistor R10A and B, and a differential amplifier stage (Q1, Q2, and associated components). The constant voltage input amplifier continuously compares a fixed reference voltage with a portion of the output voltage and, if a difference exists, produces an error voltage whose amplitude and phase is proportional to the difference. The error output is fed back to the series regulator, through an OR gate and the driver and error amplifiers. The error voltage changes the conduction of the series regulator which, in turn, alters the output voltage so that the difference between the two input voltages applied to the differential amplifier is reduced to zero. The above action maintains the output voltage constant.

4-21 Stage Q2 of the differential amplifier is connected to a common (+S) potential through impedance equalizing resistor R6. Resistor Z1B is used to zero bias the input stage, offsetting minor base-to-emitter voltage differences in Q1 and Q2. The base of Q1 is connected to a summing point at the junction of the programming resistor and the current pullout resistor, R12. Instantaneous changes in output voltage result in an increase or decrease in the summing point potential. Q1 is then made to conduct more or less, in accordance with the summing point voltage change. The resultant output error voltage is fed back to the series regulator via OR-gate diode CR5 and the remaining components of the feedback loop. Resistor R1, in series with the base of Q1, limits the current through the programming resistor during rapid voltage turn-down. Diodes CR1 and CR2 form a limiting network which prevent excessive voltage excursions from over driving stage Q1. Capacitor C1, shunting the programming resistors, increases the high frequency gain of the input amplifier.

##### 4-22 CONSTANT CURRENT INPUT AMPLIFIER

4-23 This circuit is similar in appearance and operation to the constant voltage input circuit. It consists basically of the current programming resistors R11A and B, and a differential amplifier stage (Q12, Q13, and associated components).

4-24 The constant current input amplifier continuously compares a fixed reference voltage with the voltage drop across current sampling resistor R33. If a difference exists, the differential amplifier produces an error voltage which is proportional to this difference. The remaining components in the feedback loop (amplifiers and series regulator)

function to maintain the drop across the current sampling resistor, and consequently the output current, at a constant value. R14 and R57 compensate for the current drawn by the meter when in constant current mode by drawing an equivalent amount of current when output is shorted for current setting thus assuring proper current to load.

4-25 Stage Q13 is connected to a common (+S) potential through impedance equalizing resistor R43. Resistor Q1G is used to zero bias the input stage, offsetting minor base-to-emitter voltage differences in Q12 and Q13. Instantaneous changes in output current on the positive line are felt at the base of Q12. Stage Q12 varies its conduction in accordance with the polarity of the change at the summing point. The change in conduction of Q12 also varies the conduction of Q13 due to the coupling effects of the common emitter resistor Z1H. The error voltage is taken from the collector of Q12 and fed back to the series regulator through OR-gate diode CR6 and the remaining components of the feedback loop. The error voltage then varies the conduction of the regulator so that the output current is maintained at the proper level.

4-26 Capacitor C4, in conjunction with Z1K helps stabilize the feedback loop. Diode CR20 limits voltage excursions on the base of Q12.

#### 4-27 VOLTAGE CLAMP CIRCUIT

4-28 During constant current operation the constant voltage programming resistors R10A and B are a shunt load across the output terminals of the power supply. If the output voltage varies, the current through these resistors would tend to change resulting in an output current change. The clamp circuit is a return path for the voltage programming current, the current that normally flows through the programming resistors. The circuit maintains the current into the base of Q1 constant, thus eliminating the error due to shunting effects of the constant voltage programming resistors.

4-29 The voltage divider, Z1E, Z1F, and VR2 back biases CR3 and Q3 during constant voltage operation. When the power supply goes into constant current operation, CR3 becomes forward biased by the collector voltage of Q1. This results in conduction of Q3 and the clamping of the summing point at a potential only slightly more negative than the normal constant voltage potential. Clamping this voltage at approximately the same potential that exists in constant voltage operation, results in a constant voltage across, and consequently a constant current through pullout resistor R12.

#### 4-30 DRIVER AND ERROR AMPLIFIER

4-31 The error and driver amplifiers amplify the

error signal from the constant voltage input circuit to a level sufficient to drive the series regulator transistor. Amplifier Q4 also receives a current limiting input if CR6, the current limiting diode, becomes forward biased.

4-32 Stage Q4 contains a feedback equalizer network, C3 and R17, which provides for high frequency roll off in the loop gain in order to stabilize the feedback loop.

#### 4-33 REFERENCE REGULATOR CIRCUIT

4-34 The reference regulator circuit is a separate power supply similar to the main supply. It provides stable reference voltages which are used throughout the unit. The reference voltages are all derived from smoothed dc obtained from the full wave rectifier (CR10 and CR11) and filter capacitor C5. The -6.2V and -12.4V reference voltages are derived from VR1 which is a second dc source regulating at 12.4Vdc. Current for VR1 is supplied by the (-) side of C5 and flows through VR1, the base-emitter junction of Q7, R20, and back to the positive side of C5.

4-35 The base-emitter junction of Q11 is held constant by 6.2V zener diode VR7 which regulates line voltage changes that alter the voltage across C5. Thus Q11 is a constant current source feeding 7.5V zener diode VR4, 4V diode VR5, and 6.2V temperature-compensated zener diode VR6.

4-36 Resistors R30 and VR8 form a voltage divider across the stable 12.4 Volts developed by VR1. The base-emitter junction of Q9 is therefore held constant by the voltage developed across VR8. Thus Q9 provides a constant current to zener diode VR3 which regulates the -6.2V source.

#### 4-37 METER CIRCUIT

4-38 This circuit provides indication of output voltage or current. With METER SELECTION switch S2 set to V position, the meter is in series with R54, and R52 across the output of the supply.

4-39 With METER SELECTION switch S2 set to mA position, the meter is connected in series with R52 and R53 across current sampling resistor R33. CURRENT ADJ potentiometer R52 is adjusted for full scale deflection with a full load connected to the output terminals. Resistors R55, R14, and R57 are connected across the current sampling resistor R33 when S2 is set to V position. It prevents the current sampling resistor from indicating an erroneous current by simulating the meter circuit, which is connected across the current sampling resistor in the current mode.

## SECTION V MAINTENANCE

### 5-1 INTRODUCTION

5-2 Upon receipt of the power supply, the performance check (Paragraph 5-8 ) should be made. This check is suitable for incoming inspection. If a fault is detected in the power supply while making the performance check or during normal operation, proceed to the troubleshooting procedures (Paragraph 5-57). After troubleshooting and repair (Paragraph 5-65), perform any necessary adjustments and calibrations (Paragraph 5-67). Before returning the power supply to normal operation, repeat the performance check to ensure that the fault has been properly corrected and that no other faults exist.

### 5-3 COVER REMOVAL AND REPLACEMENT

5-4 To remove the top and bottom covers, proceed as follows:

- a. Insert a small screwdriver in each of the four notches at the front of the unit at the top and bottom. Push the screwdriver under the front panel and gently pry toward the front of the unit to release the holding mechanism.
- b. Pull the front panel forward until it clears

the top and bottom covers.

- c. Remove the rear cover by repeating step a.
- d. Pull the rear cover until it clears the top and bottom covers. Then lift off the top cover and lift the unit out of the bottom cover.

5-5 To replace the top and bottom covers, proceed as follows:

- a. Place the unit into the bottom cover (identified by the four protruding feet) and align the heat sink into the track in the bottom cover.
- b. Place the top cover over the unit and align the track over the heat sink.
- c. While holding the covers together at the rear of the unit, carefully push on the rear panel.
- d. Position the front panel so that the two slotted ears at the bottom of the panel align with the printed wiring boards.
- e. Carefully push on the front panel.

### 5-6 TEST EQUIPMENT REQUIRED

5-7 Table 5-1 lists the test equipment required to perform the various procedures described in this Section.

Table 5-1. Test Equipment Required

TYPE	REQUIRED CHARACTERISTICS	USE	RECOMMENDED MODEL
Differential Voltmeter	Sensitivity: 1mV full scale (min.). Input impedance: 10 megohms (min.).	Measure dc voltages; calibration procedures	Ⓢ 3420 (See Note)
Variable Voltage Transformer	Range: 90-130 Volts. Equipped with voltmeter accurate within 1 Volt.	Vary ac input	-----
AC Voltmeter	Accuracy: 2%. Sensitivity: 1mV full scale deflection (min.).	Measure ac voltages and ripple	Ⓢ 403B
Oscilloscope	Sensitivity: 100 $\mu$ V/cm. Differential input.	Display transient response waveforms	Ⓢ 140A plus 1400A plug-in. 1402A plug-in for spike measurements only.
Oscillator	Range: 5Hz to 600kHz. Accuracy: 2%. Output: 10Vrms.	Impedance checks	Ⓢ 200CD

Table 5-1. Test Equipment Required (Continued)

TYPE	REQUIRED CHARACTERISTICS	USE	RECOMMENDED MODEL
DC Voltmeter	Accuracy: 1%. Input resistance: 20,000 ohms/Volt (min.).	Measure dc voltages	Ⓢ 412A
Repetitive Load Switch	Rate: 60-400Hz, 2μsec rise and fall time.	Measure transient response	See Figure 5-7.
Resistive Loads	Values: See Paragraph 5-16.	Power supply load resistors	-----
Current Sampling Resistor	See R33 in Parts List (Section VI).	Measure current; calibrate meter	-----
Resistor	1K $\Omega$ $\pm$ 1%, 2 Watt non-inductive.	Measure impedance	-----
Resistor	100 ohms, $\pm$ 5%, 10 Watt.	Measure impedance	-----
Capacitor	500 $\mu$ f, 50W Vdc.	Measure impedance	-----

**NOTE**

A satisfactory substitute for a differential voltmeter is to arrange a reference voltage source and null detector as shown in Figure 5-1. The reference voltage source is adjusted so that the voltage difference between the supply being measured and the reference voltage will have the required resolution for the measurement being made. The voltage difference will be a function of the null detector that is used. Examples of satisfactory null detectors are: Ⓢ419A null detector, a dc coupled oscilloscope utilizing differential input, or a 50mV meter movement with a 100 division scale. For the latter, a 2mV change in voltage will result in a meter deflection of four divisions.

**CAUTION**

Care must be exercised when using an electronic null detector in which one input terminal is grounded to avoid ground loops and circulating currents.

**5-8 PERFORMANCE TEST**

5-9 The following test can be used as an incoming inspection check and appropriate portions of the test can be repeated either to check the opera-

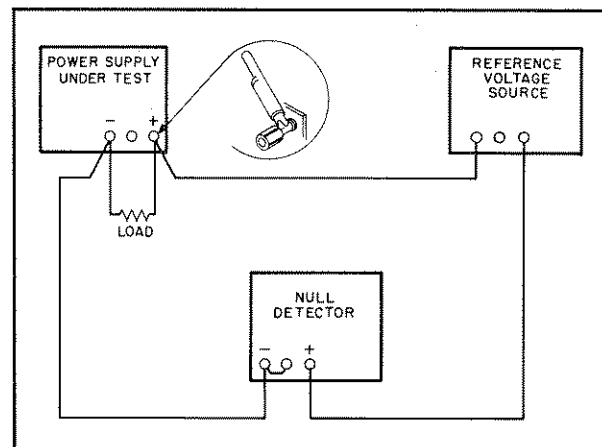

Figure 5-1. Differential Voltmeter Substitute Test Setup

tion of the instrument after repairs or for periodic maintenance tests. The tests are performed using a 115Vac, 60Hz, single phase input power source. If the correct result is not obtained for a particular check, do not adjust any controls; proceed to troubleshooting (Paragraph 5-57).

**5-10 CONSTANT VOLTAGE TESTS**

5-11 The measuring device must be connected as close to the output terminals as possible when measuring the output impedance, transient response, regulation, or ripple of the power supply in order to achieve valid measurements. A measure-

ment made across the load includes the impedance of the leads to the load and such lead lengths can easily have an impedance several orders of magnitude greater than the supply impedance, thus invalidating the measurement.

5-12 The monitoring device should be connected as shown in Figure 5-2. Note that the monitoring leads are connected at A, not B, as shown in Figure 5-2. Failure to connect the measuring device at A will result in a measurement that includes the resistance of the leads between the output terminals and the point of connection. When measuring the constant voltage performance specifications, the current controls should be set well above the maximum output current which the supply will draw, since the onset of constant current action will cause a drop in output voltage, increased ripple, and other performance changes not properly ascribed to the constant voltage operation of the supply.

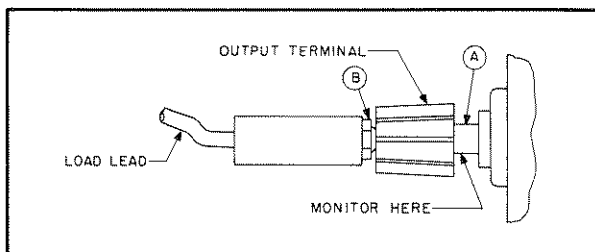

Figure 5-2. Front Panel Terminal Connections

#### 5-13 Rated Output and Meter Accuracy.

5-14 Voltage. To check the output voltage, proceed as follows:

- Connect load resistor ( $R_L$ ), indicated in Figure 5-3, across the output terminals of supply.
- Connect differential voltmeter across (+) and (-) terminals of supply observing correct polarity.
- Set METER SELECTION switch to VOLTS and turn on supply.
- Adjust VOLTAGE controls until front panel meter indicates exactly the maximum rated output voltage.
- Differential voltmeter should indicate maximum rated output voltage within  $\pm 3\%$ .

#### 5-15 Load Regulation.

Definition: The change  $\Delta E_{OUT}$  in the static value of dc output voltage resulting from a change in load resistance from open circuit to a value which yields maximum rated output current (or vice versa).

5-16 To check the constant voltage load regulation, proceed as follows:

- Connect test setup as shown in Figure 5-3.

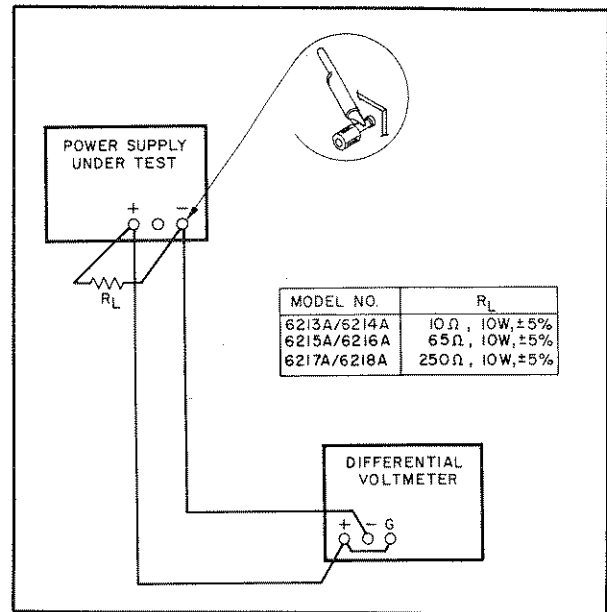

Figure 5-3. CV Load Regulation, Test Setup

- Set METER SELECTION switch to mA position.
- Turn on supply and adjust VOLTAGE controls until front panel meter indicates maximum rated output current.
- Read and record voltage indicated on differential voltmeter.
- Disconnect load resistor.
- Reading on differential voltmeter should not vary from reading recorded in step d by more than 4mVdc.

#### 5-17 Line Regulation

Definition: The change,  $\Delta E_{OUT}$ , in the static value of dc output voltage resulting from a change in ac input voltage over the specified range from low line (usually 105 Volts) to high line (usually 125 Volts), or from high line to low line.

5-18 To test the line regulation, proceed as follows:

- Connect variable auto transformer between input power source and power supply power input.
- Connect test setup shown in Figure 5-3.
- Adjust variable auto transformer for 103V ac input.
- Set METER SELECTION switch to VOLTS

position.

e. Turn on supply and adjust VOLTAGE controls until front panel meter indicates exactly the maximum rated output voltage.

f. Read and record voltage indicated on differential voltmeter.

g. Adjust variable auto transformer for high VAC input.

h. Reading on differential voltmeter should not vary from reading recorded in step f by more than 4mVdc.

#### 5-19 Ripple and Noise.

Definition: The residual AC voltage which is superimposed on the DC output of a regulated power supply. Ripple and noise may be specified and measured in terms of its RMS or (preferably) peak-to-peak value.

Ripple and noise measurement can be made at any input AC line voltage combined with any DC output voltage and load current within rating.

5-20 The amount of ripple and noise that is present on the power supply output is measured either in terms of the RMS or (preferably) peak-to-peak value. The peak-to-peak measurement is particularly important for applications where noise spikes could be detrimental to a sensitive load, such as logic circuitry. The RMS measurement is not an ideal representation of the noise, since fairly high output noise spikes of short duration could be present in the ripple and not appreciably increase the RMS value.

5-21 The technique used to measure high frequency noise or "spikes" on the output of a power supply is more critical than the low frequency ripple and noise measurement technique; therefore the former is discussed separately in Paragraph 5-29.

5-22 Ripple and Noise Measurements. Figure 5-4A shows an incorrect method of measuring p-p ripple. Note that a continuous ground loop exists from the third wire of the input power cord of the supply to the third wire of the input power cord of the oscilloscope via the grounded power supply case, the wire between the negative output terminal of the power supply and the vertical input of the scope, and the grounded scope case. Any ground current circulating in this loop as a result of the difference in potential  $E_G$  between the two ground points causes an IR drop which is in series with the scope input. This IR drop, normally having a 60Hz line frequency fundamental, plus any pickup on the unshielded leads interconnecting the power supply and scope, appears on the face of the CRT. The magnitude of this resulting noise signal can easily be much greater than the

true ripple developed between the plus and minus output terminals of the power supply, and can completely invalidate the measurement.

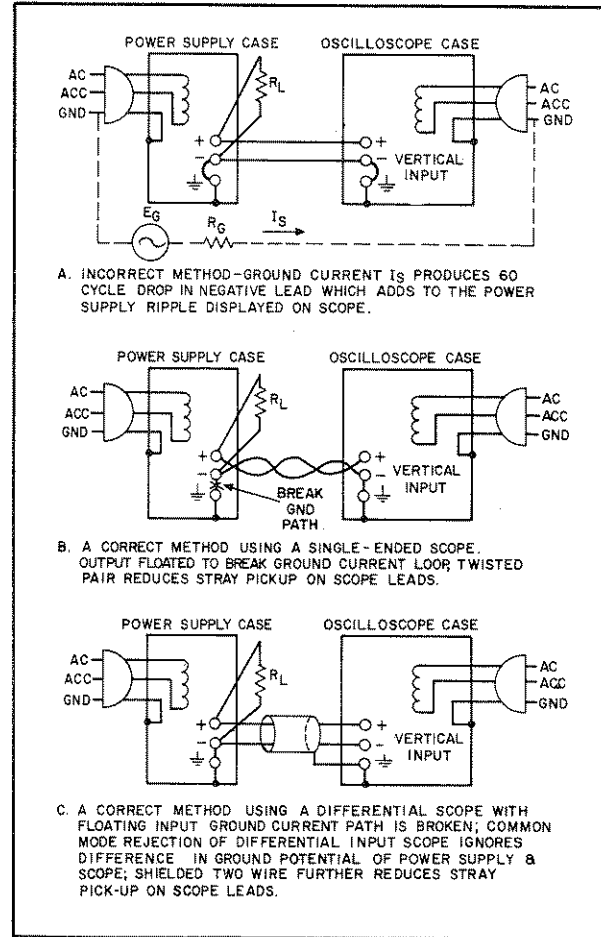

Figure 5-4. Ripple and Noise, Test Setup

5-23 The same ground current and pickup problems can exist if an RMS voltmeter is substituted in place of the oscilloscope in Figure 5-4. However, the oscilloscope display, unlike the true RMS meter reading, tells the observer immediately whether the fundamental period of the signal displayed is 8.3 milliseconds ( $1/120\text{Hz}$ ) or 16.7 milliseconds ( $1/60\text{Hz}$ ). Since the fundamental ripple frequency present on the output of an  $\text{ac}$  supply is 120Hz (due to full-wave rectification), an oscilloscope display showing a 120Hz fundamental component is indicative of a "clean" measurement setup, while the presence of a 60Hz fundamental usually means that an improved setup will result in a more accurate (and lower) value of measured ripple.



5-24 Figure 5-4B shows a correct method of measuring the output ripple of a constant voltage power supply using a single-ended scope. The ground loop path is broken by floating the power supply. Note that to ensure that no potential difference exists between the supply and the oscilloscope it is recommended that whenever possible they both be plugged into the same ac power buss. If the same buss cannot be used, both ac grounds must be at earth ground potential.

5-25 Either a twisted pair or (preferably) a shielded two-wire cable should be used to connect the output terminals of the power supply to the vertical input terminals of the scope. When using a twisted pair, care must be taken that one of the two wires is connected to the grounded input terminal of the oscilloscope. When using shielded two-wire, it is essential for the shield to be connected to ground at one end only so that no ground current will flow through this shield, thus inducing a noise signal in the shielded leads.

5-26 To verify that the oscilloscope is not displaying ripple that is induced in the leads or picked up from the grounds, the (+) scope lead should be shorted to the (-) scope lead at the power supply terminals. The ripple value obtained when the leads are shorted should be subtracted from the actual ripple measurement.

5-27 In most cases, the single-ended scope method of Figure 5-4B will be adequate to eliminate non-real components of ripple and noise so that a satisfactory measurement may be obtained. However, in more stubborn cases it may be necessary to use a differential scope with floating input as shown in Figure 5-4C. If desired, two single conductor shielded cables may be substituted in place of the shielded two-wire cable with equal success. Because of its common mode rejection, a differential oscilloscope displays only the difference in signal between its two vertical input terminals, thus ignoring the effects of any common mode signal introduced because of the difference in the AC potential between the power supply case and scope case. Before using a differential input scope in this manner, however, it is imperative that the common mode rejection capability of the scope be verified by shorting together its two input leads at the power supply and observing the trace on the CRT. If this trace is a straight line, the scope is properly ignoring any common mode signal present. If this trace is not a straight line, then the scope is not rejecting the ground signal and must be realigned in accordance with the manufacturer's instructions until proper common mode rejection is attained.

5-28 To check the ripple and noise output, proceed as follows:

- Connect the oscilloscope or RMS voltmeter as shown in Figures 5-4B or 5-4C.
- Adjust VOLTAGE control until front panel meter indicates maximum rated output voltage.
- The observed ripple and noise should be less than  $200\mu\text{V}_{\text{rms}}$  and  $1\text{mV p-p}$ .

5-29 Noise Spike Measurement. When a high frequency spike measurement is being made, an instrument of sufficient bandwidth must be used; an oscilloscope with a bandwidth of 20MHz or more is adequate. Measuring noise with an instrument that has insufficient bandwidth may conceal high frequency spikes detrimental to the load.

5-30 The test setups illustrated in Figures 5-4A and 5-4B are generally not acceptable for measuring spikes; a differential oscilloscope is necessary. Furthermore, the measurement concept of Figure 5-4C must be modified if accurate spike measurement is to be achieved:

- As shown in Figure 5-5, two coax cables, must be substituted for the shielded two-wire cable.

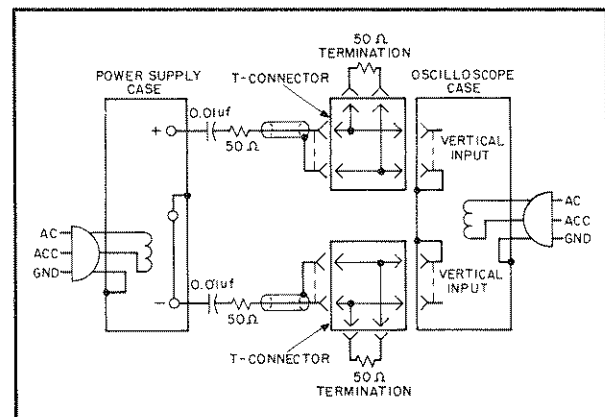

Figure 5-5. CV Noise Spike Test Setup

- Impedance matching resistors must be included to eliminate standing waves and cable ringing, and the capacitors must be connected to block the DC current path.
- The length of the test leads outside the coax is critical and must be kept as short as possible; the blocking capacitor and the impedance matching resistor should be connected directly from the inner conductor of the cable to the power supply terminals.

d. Notice that the shields of the power supply end of the two coax cables are not connected to the power supply ground, since such a connection would give rise to a ground current path through the coax shield, resulting in an erroneous measurement.

e. The measured noise spike values must be doubled, since the impedance matching resistors constitute a 2-to-1 attenuator.

f. The noise spikes observed on the oscilloscope should be less than 0.5mV p-p.

5-31 The circuit of Figure 5-5 can also be used for the normal measurement of low frequency ripple and noise; simply remove the four terminating resistors and the blocking capacitors and substitute a higher gain vertical plug-in in place of the wide-band plug-in required for spike measurements. Notice that with these changes, Figure 5-5 becomes a two-cable version if Figure 5-4C.

### 5-32 Output Impedance

Definition: At any given frequency of load change,  $\Delta E_{OUT} / \Delta I_{OUT}$ . Strictly speaking the definition applies only for a sinusoidal load disturbance, unless, of course, the measurement is made at zero frequency (DC). The output impedance of an ideal constant voltage power supply would be zero at all frequencies, while the output impedance for an ideal constant current power supply would be infinite at all frequencies.

The output impedance of a power supply is normally not measured, since the measurement of transient recovery time reveals both the static and dynamic output characteristics with just one measurement. The output impedance of a power supply is commonly measured only in those cases where the exact value at a particular frequency is of engineering importance.

5-33 To check the output impedance, proceed as follows:

- Connect test setup shown in Figure 5-6.
- Set METER SELECTION switch to VOLTS position.
- Turn on supply and adjust VOLTAGE controls until front panel meter reads 20 Volts.
- Set AMPLITUDE control on Oscillator to 10 Volts ( $E_{in}$ ), and FREQUENCY control to 100Hz.
- Record voltage across output terminals of the power supply ( $E_o$ ) as indicated on AC voltmeter.
- Calculate the output impedance by the following formula:

$$Z_{out} = \frac{E_o R}{E_{in} - E_o}$$

$E_o$  = rms voltage across power supply output terminals.

$R = 1000$

$E_{in} = 10$  Volts

g. The output impedance ( $Z_{out}$ ) should be less than 0.030 ohms.

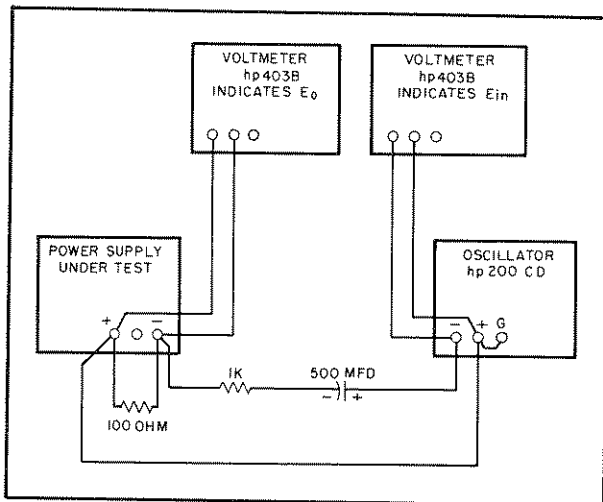

Figure 5-6. Output Impedance, Test Setup

h. Using formula of step f, calculate output impedance at frequencies of 50kHz and 500kHz. Values should be less than 0.5 ohm and 3.0 ohms, respectively.

### 5-34 Transient Recovery Time

Definition: The time "X" for output voltage recovery to within "Y" millivolts of the nominal output voltage following a "Z" amp step change in load current — where: "Y" is specified separately for each model but is generally of the same order as the load regulation specification. The nominal output voltage is defined as the DC level half way between the static output voltage before and after the imposed load change, and "Z" is the specified load current change, normally equal to the full load current rating of the supply.

5-35 Transient recovery time may be measured at

any input line voltage combined with any output voltage and load current within rating.

5-36 Reasonable care must be taken in switching the load resistance on and off. A hand-operated switch in series with the load is not adequate, since the resulting one-shot displays are difficult to observe on most oscilloscopes, and the arc energy occurring during switching action completely masks the display with a noise burst. Transistor load switching devices are expensive if reasonably rapid load current changes are to be achieved.

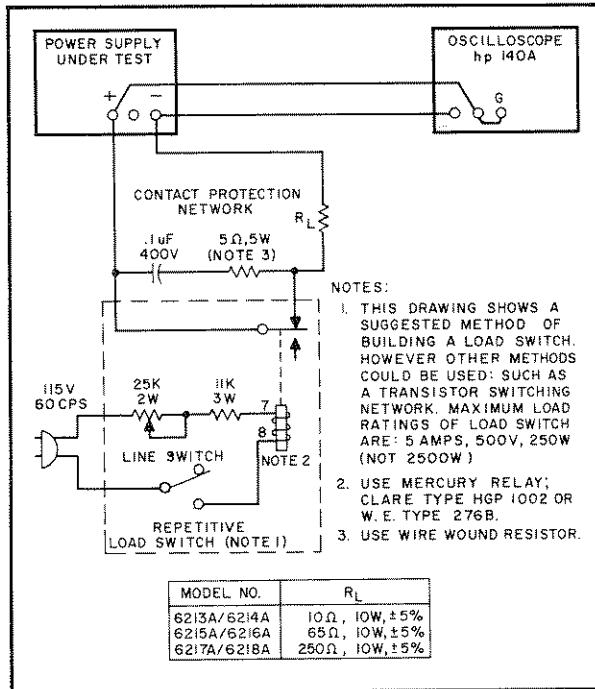

Figure 5-7. Transient Recovery Time, Test Setup

5-37 A mercury-wetted relay, as connected in the load switching circuit of Figure 5-7 should be used for loading and unloading the supply. When this load switch is connected to a 60Hz AC input, the mercury-wetted relay will open and close 60 times per second. Adjustment of the 25K control permits adjustment of the duty cycle of the load current switching and reduction in jitter of the oscilloscope display.

5-38 The maximum load ratings listed in Figure 5-7 must be observed in order to preserve the mercury-wetted relay contacts. Switching of larger load currents can be accomplished with mercury pool relays; with this technique fast rise times can still be obtained, but the large inertia of mercury pool relays limits the maximum repetition rate of load

switching and makes the clear display of the transient recovery characteristic on an oscilloscope more difficult.

5-39 To check the transient recovery time, proceed as follows:

- Connect test setup shown in Figure 5-7.
- Set METER SELECTION switch to mA.
- Turn on supply and adjust voltage controls until front panel meter indicates exactly the maximum rated output current.
- Close the line switch on the repetitive load switch setup.
- Set the oscilloscope for internal sync and lock on either the positive or negative load transient spike.
- Set the vertical input of the oscilloscope for ac coupling so that small dc level changes in the output voltage of the power supply will not cause the display to shift.
- Adjust the vertical centering on the scope so that the tail ends of the no load and full load waveforms are symmetrically displaced about the horizontal center line of the oscilloscope. This center line now represents the nominal output voltage defined in the specification.
- Adjust the horizontal positioning control so that the trace starts at a point coincident with a major graticule division. This point is then representative of time zero.
- Increase the sweep rate so that a single transient spike can be examined in detail.
- Adjust the sync controls separately for the positive and negative going transients so that not only the recovery waveshape but also as much as possible of the rise time of the transient is displayed.
- Starting from the major graticule division representative of time zero, count to the right 50μsec and vertically 15mV. Recovery should be within these tolerances as illustrated in Figure 5-8.

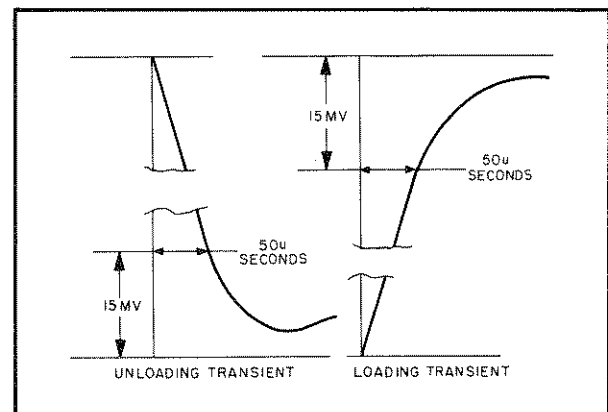

Figure 5-8. Transient Recovery Time, Waveforms

5-40 Temperature Coefficient

Definition: The change in output voltage per degree Centigrade change in the ambient temperature under conditions of constant input AC line voltage, output voltage setting, and load resistance.

5-41 The temperature coefficient of a power supply is measured by placing the power supply in an oven and varying it over any temperature span within its rating. (Most power supplies are rated for operation from 0°C to 55°C.) The power supply must be allowed to thermally stabilize for a sufficient period of time at each temperature of measurement.

5-42 The temperature coefficient specified is the maximum temperature-dependent output voltage change which will result over any 5°C interval. The differential voltmeter or digital voltmeter used to measure the output voltage change of the supply should be placed outside the oven and should have a long term stability adequate to insure that its drift will not affect the overall measurement accuracy.

5-43 To check the temperature coefficient, proceed as follows:

- a. Connect the load resistance, attenuator, and differential voltmeter as illustrated in Figure 5-3.
- b. Adjust front panel VOLTAGE controls until the front panel voltmeter indicates as follows:  
6214A, 10V; 6216A, 25V; 6218A, 50V
- c. Insert the power supply into the temperature-controlled oven (differential voltmeter remains outside oven). Set the temperature to 30°C and allow 30 minutes warm-up.
- d. Record the differential voltmeter indication.
- e. Raise the temperature to 40°C and allow 30 minutes warm-up.
- f. Observe the differential voltmeter indication. The difference in the voltage indication of step d and f should be less than the following:

6214A 30mV  
 6216A 60mV  
 6218A 120mV

5-44 Output Stability

Definition: The change in output voltage for the first eight hours following a 30 minute warm-up period. During the interval of measurement all parameters, such as load resistance, ambient temperature, and input line voltage are held constant.

5-45 This measurement is made by monitoring the output of the power supply on a differential voltmeter or digital voltmeter over the stated measurement interval; a strip chart recorder can be used to provide a permanent record. A thermometer should be placed near the supply to verify that the ambient temperature remains constant during the period of measurement. The supply should be put in a location immune from stray air currents (open doors or windows, air conditioning vents); if possible, the supply should be placed in an oven which is held at a constant temperature. Care must be taken that the measuring instrument has a stability over the eight hour interval which is at least an order of magnitude better than the stability specification of the power supply being measured. Typically, a supply may drift less over the eight hour measurement interval than during the 1/2 hour warm-up period.

5-46 To check the output stability, proceed as follows:

- a. Connect the load resistance and differential voltmeter as illustrated in Figure 5-3.
- b. Adjust front panel VOLTAGE controls until the differential voltmeter indicates the following:  
6214A 10V  
6216A 25V  
6218A 50V
- c. Allow 30 minutes warm-up then record the differential voltmeter indication.
- d. After 8 hours, differential voltmeter should change from indication recorded in step c by less than the following:

6214A 15mV  
 6216A 30mV  
 6218A 55mV

5-47 CONSTANT CURRENT TESTS

5-48 For output current measurements, the current sampling resistor must be treated as a four terminal device. In the manner of a meter shunt, the load current is fed to the extremes of the wire

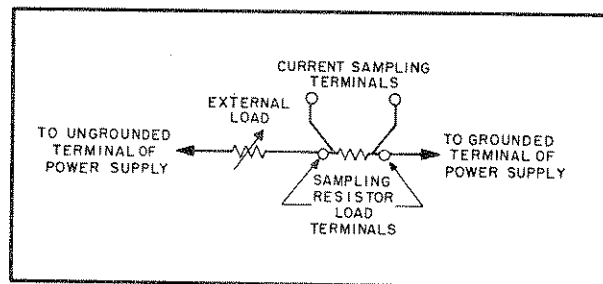

Figure 5-9. Current Sampling Resistor Connections

leading to the resistor while the sampling terminals are located as close as possible to the resistance portion itself (see Figure 5-9). Generally, any current sampling resistor should be of the low noise, low temperature coefficient (less than 30ppm/°C) type and should be used at no more than 5% of its rated power so that its temperature rise will be minimized. The latter, reduces resistance changes due to thermal fluctuations. It is recommended that the user obtain a duplicate of the sampling resistance (R33) that is used in this unit for constant current checks.

#### 5-49 Rated Output and Meter Accuracy

- a. Connect test setup shown in Figure 5-10.

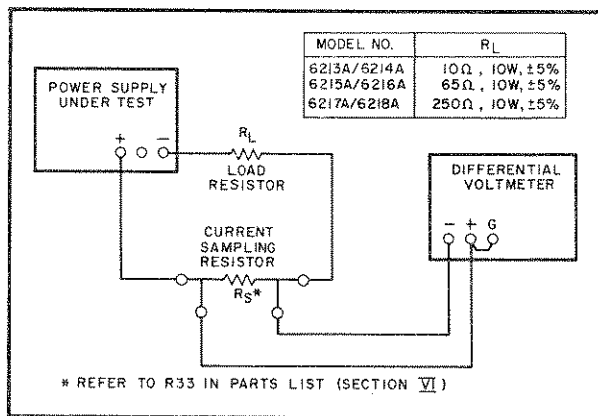

Figure 5-10. Constant Current, Test Setup

- b. Set METER SELECTION switch to mA position.
- c. Turn CURRENT controls fully clockwise.
- d. Turn on supply and adjust VOLTAGE controls until front panel meter indicates maximum rated output current.
- e. Differential voltmeter should read  $1.2 \pm 0.036V$  for Models 6216A and 6218A, and  $1 \pm 0.03V$  Model 6214A.

#### 5-50 Load Regulation

Definition: The change,  $\Delta I_{OUT}$  in the static value of the dc output current resulting from a change in load resistance from short circuit to a value which yields maximum rated output voltage.

5-51 To check the constant current load regulation, proceed as follows:

- a. Connect test setup shown in Figure 5-10.
- b. Turn VOLTAGE control(s) fully clockwise.
- c. Set METER switch to mA.
- d. Adjust CURRENT control until front panel

meter reads exactly the maximum rated output current.

- e. Read and record voltage indicated on differential voltmeter.
- f. Short out load resistor ( $R_L$ ).
- g. Reading on differential voltmeter should not vary from reading recorded in step e by more than the following:

Model No.	6214A	6216A	6218A
Variation (mVdc)	0.5	1.5	3

#### 5-52 Line Regulation

Definition: The change,  $\Delta I_{OUT}$  in the static value of dc output current resulting from a change in ac input voltage over the specified range from low line (usually 103 Volts) to high line (usually 127 Volts), or from high line to low line.

5-53 To check the line regulation proceed as follows:

- a. Utilize test setup shown in Figure 5-10.
- b. Connect variable auto transformer between input power source and power supply power input.
- c. Adjust auto transformer for 103Vac input.
- d. Turn VOLTAGE control(s) fully clockwise.
- e. Set METER switch to mA.
- f. Adjust CURRENT controls until front panel meter reads exactly the maximum rated output current.
- g. Read and record voltage indicated on differential voltmeter.
- h. Adjust variable auto transformer for 127 Vac input.

i. Reading on differential voltmeter should not vary from reading recorded in step g by more than the following:

Model No.	6214A	6216A	6218A
Variation (mVdc)	0.75	1.5	3.0

#### 5-54 Ripple and Noise

Definition: The residual ac current which is superimposed on the dc output current of a regulated supply. Ripple and noise may be specified and measured in terms of its RMS or (preferably) peak-to-peak value.

5-55 Most of the instructions pertaining to the ground loop and pickup problems associated with constant voltage ripple and noise measurement also apply to the measurement of constant current ripple and noise. Figure 5-11 illustrates the most important precautions to be observed when measuring the ripple and noise of a constant current supply. The presence of a 120 cycle waveform on the oscilloscope is normally indicative of a correct measurement method. A waveshape having 60Hz as

its fundamental component is typically associated with an incorrect measurement setup.

5-56 Ripple and Noise Measurement. To check the peak-to-peak ripple and noise, proceed as follows:

- a. Connect the oscilloscope as shown in Figures 5-11B or 5-11C.
- b. Rotate the VOLTAGE control fully cw.
- c. Set METER switch to mA and turn on supply.
- d. Adjust CURRENT control until front panel meter reads exactly the maximum rated output current.
- e. The peak-to-peak ripple and noise indication should be less than:
 

6212A	6214A	6216A	6218A
5.0mV	0.5mV	1.5mV	3.0mV

### 5-57 TROUBLESHOOTING

5-58 Before attempting to troubleshoot this instrument, ensure that the fault is with the instrument and not with an associated circuit. The performance test (Paragraph 5-8) enables this to be determined without having to remove the instrument from the cabinet.

5-59 A good understanding of the principles of operation is a helpful aid in troubleshooting, and it is recommended that the reader review Section IV of the manual before attempting to troubleshoot the unit in detail. Once the principles of operation are understood, refer to the overall troubleshooting procedures in Paragraph 5-61 to locate the symptom and probable cause.

### NOTE

The normal voltages shown on the schematic diagram at the rear of the manual are positioned adjacent to the applicable test points (identified by encircled numbers on the component location diagram and schematic diagram, Figures 7-1 and 7-2).

5-60 Once the defective component has been located (by means of visual inspection or trouble analysis) replace it and reconduct the performance test. If a component is replaced, refer to the repair and replacement and adjustment and calibration paragraphs in this section.

### 5-61 OVERALL TROUBLESHOOTING PROCEDURE

5-62 To locate the cause of trouble follow steps 1, 2, and 3 in sequence.

(1) Check for obvious troubles such as open fuse, defective power cord, input power failure, or

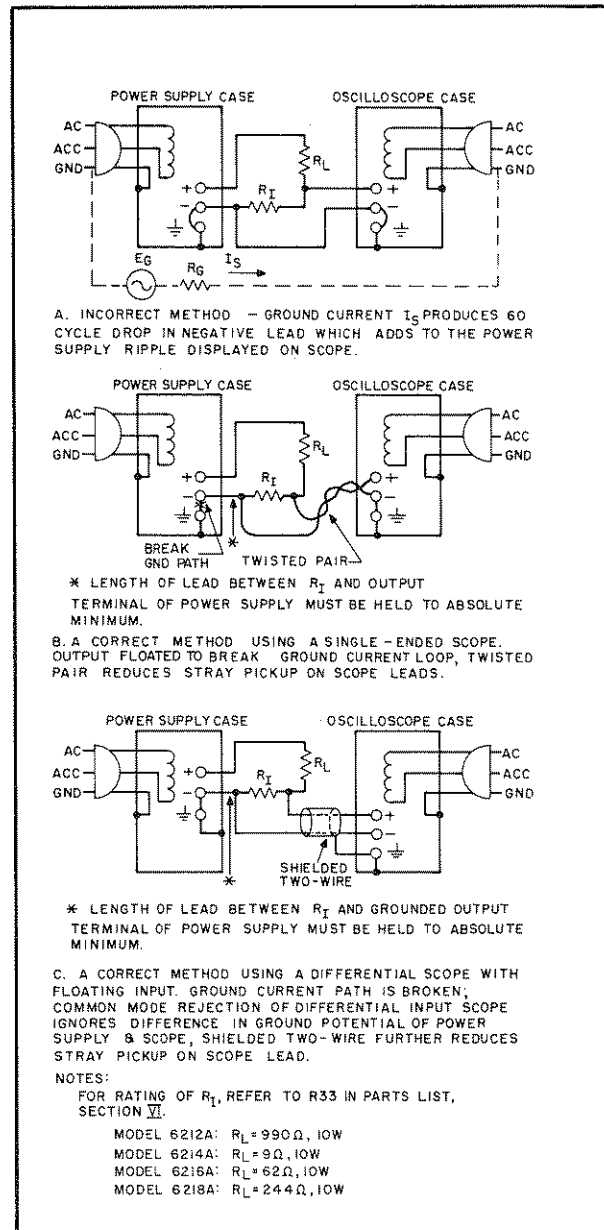

Figure 5-11. CC Ripple and Noise Test Setup

defective voltage or current meter. Next remove the top and bottom covers, as described in Paragraph 5-3, and inspect for open connections, charred components, etc. If the trouble source cannot be detected by visual inspection, proceed with step 2.

(2) In almost all cases, the trouble can be caused by the dc bias or reference voltages; thus, it is a good practice to check voltages in Table 5-2 before proceeding with step 3.

(3) Examine Table 5-3 to determine your symptom, then check the probable cause.

Table 5-2. Reference, Bias, and Filtered DC Troubleshooting

METER COMMON	METER POSITIVE	NORMAL VDC	NORMAL RIPPLE (P-P)	PROBABLE CAUSE
C5 (-)	C5 (+)	+48 ± 4.8V	2V	T1, C10, CR10, CR11, C5
+S	7	+11.5 ± 0.0V	0.5mV	VR4, Q11, VR7
+S	8	+6.2 ± 0.3V	0.2mV	VR6, R25
9	+S	+6.2 ± 0.3V	0.1mV	VR3, Q9, R30, VR8
11	+S	+12.4 ± 0.6V	4.5mV	VR1, VR8, R30
-OUT	6	19 ± 2.2V (6214A) 44 ± 4.5V (6216A) 78 ± 7.8V (6218A)	3V 400mV 500mV	CR15, CR16, C9, R32, T1

Table 5-3. Overall Troubleshooting

SYMPTOM	PROBABLE CAUSE
Low Output Or No Output Voltage	Insure that the front panel meter is not defective, then refer to paragraph 5-63.
High Output Voltage	Insure that the front panel meter is not defective, then refer to paragraph 5-63.
<p><b>CAUTION</b></p> <p>Never set the output voltage controls to zero volts when there is high or low output voltage; damage to the voltage controls could result.</p>	
Inability To Reach 0V ±1mV Output	a. Output voltage control R10 defective. b. Amplifier Q1, Q2 defective.
Oscillates	C3, R17 defective
Slow Drift	a. Measuring equipment b. Reference diode VR6 c. Q1 or Q2 d. Insufficient warm-up time (should be 30 minutes).
High Ripple	a. Check operating setup for ground loops.

Table 5-3. Overall Troubleshooting (Continued)

SYMPTOM	PROBABLE CAUSE
High Ripple (Cont'd)	b. If output floating, connect 1µf capacitor between output and ground. c. Check for excessive internal ripple; refer to Table 5-2. d. Ensure that supply is not in constant current mode under loaded conditions. e. Check that test point (15) is approx. -0.5V. If voltage is between 0 and +3V, supply is in constant current operation or constant current input amplifier is defective.
Poor Transient Recovery Time	R17, C3 defective
Poor Line Regulation (Constant Voltage)	a. Improper measuring technique; refer to paragraph 5-11. b. Check reference circuit voltages, Table 5-2.
Poor Load Regulation (Constant Voltage)	a. Improper measuring technique; refer to paragraph 5-11. b. Check reference circuit voltages (Table 5-2)

Table 5-3. Overall Troubleshooting (Continued)

SYMPTOM	PROBABLE CAUSE
Poor Load Regulation (Constant Voltage) (Cont'd)	c. Ensure that supply is not in constant current operation under loaded conditions. To prevent this condition, ensure that output current does not exceed maximum rated output and that the current controls are fully clockwise.
Poor Stability (Constant Voltage)	a. Check +6, 2Vdc reference voltage (Table 5-2). b. Noisy programming resistor R10. c. CR1, CR2 leaky. d. Check R1, R12, and C1 for noise or drift. e. Stage Q1/Q2 defective.
Poor Load Regulation (Constant Current)	a. Improper measuring technique; refer to paragraph 5-48. b. Check reference circuit voltages (Table 5-2) and c. C14 and CR14 leaky. d. Check clamp circuit Q3, CR3, CR4, and VR2. e. Ensure that supply is not crossing over into constant voltage operation. To prevent this condition, load the supply and turn the VOLTAGE control fully clockwise.

Table 5-3. Overall Troubleshooting (Continued)

SYMPTOM	PROBABLE CAUSE
Poor Stability (Constant Current)	a. Check -6, 2Vdc reference voltage (Table 5-2). b. Noisy programming resistor R11. c. CR20, CR14, C14 leaky. d. Check R42, R48, and R33 for noise or drift. e. Stage Q12/Q13 defective.

5-63 Regulating Loop Troubles. If the voltages in Table 5-2 have been checked to eliminate the reference, bias and rectifier circuits as a source of trouble; the malfunction is caused by the voltage regulating loop. If any component in a feedback loop is defective, measurements made anywhere in the loop may appear abnormal. Under these circumstances it is very difficult to separate cause from effect with the loop closed. As described in Tables 5-4 and 5-5, the loop is effectively opened by checking the conduction and cutoff capability of each stage as follows:

1. Shorting the emitter to collector of a transistor simulates saturation, or the full ON condition.
2. Shorting the emitter to base or opening the collector lead of a transistor cuts it off, and simulates an open circuit between emitter and collector.

5-64 For low or high output voltage perform the instructions in Tables 5-4, or 5-5, respectively. Although a logical first choice might be to start near the loop mid-point, and then perform successive subdividing test, it is more useful to trace the loop from the series regulator backwards a stage at a time, since loop failures occur more often at the higher power levels.

Table 5-4. Low Output Voltage Troubleshooting

STEP	ACTION	RESPONSE	PROBABLE CAUSE
1	Turn the VOLTAGE control fully clockwise and disconnect the load		
2	To eliminate the constant current circuit as a cause of the malfunction, remove CR6 cathode or anode lead	a. Output increases b. Output remains low	a. CR6 or constant current amplifier defective b. Reconnect CR6 and proceed to Step 3



Table 5-4. Low Output Voltage Troubleshooting (Continued)

STEP	ACTION	RESPONSE	PROBABLE CAUSE
3	Check conduction of Q7 by disconnecting Q5 emitter lead	a. Output remains low b. Output increases	a. Q7, CR7 or associated parts defective b. Remove jumper and proceed to Step 4
4	Check turnoff of Q5 by shorting Q4 emitter to collector	a. Output remains low b. Output increases	a. Q5, CR13, R20 defective b. Remove jumper and proceed to Step 5
5	Check conduction of Q4 by shorting Q1 emitter to collector	a. Output remains low b. Output increases	a. Stage Q4 defective b. Stage Q1/Q2 defective. Check R10, C1 for short and R12 for open.

Table 5-5. High Output Voltage Troubleshooting

STEP	ACTION	RESPONSE	PROBABLE CAUSE
1	Turn the VOLTAGE control to approximately mid-range and disconnect the load. If the output voltage should rise to an excessive value during the following procedures, the VOLTAGE control could be damaged if it is turned full CCW.		
2	Check turnoff of Q7 by shorting Q5 emitter to collector	a. Output remains high b. Output decreases	a. Q7, CR7 or associated parts defective b. Remove short across Q5 and proceed to Step 3
3	Check conduction of Q5 by removing Q4 collector lead	a. Output remains high b. Output decreases	a. Stage Q5 defective b. Replace Q4 collector lead and proceed to Step 4
4	Check turnoff of Q4 by removing Q1 collector lead	a. Output remains high b. Output decreases	a. Stage Q4 defective b. Replace Q1 collector lead and proceed to Step 5
5	Remove CR3 anode or cathode	a. Output decreases b. Output remains high	a. Voltage clamp circuit is defective b. Reconnect CR3 and proceed to Step 6
6	Connect a jumper between (-) out and test point (1)	a. Output remains high b. Output decreases	a. Stage Q1/Q2 defective b. Remove short and check R10 for open and R12 for short

Excessive heat or pressure can lift the copper strip from the board. Avoid damage by using a low power soldering iron (50 watts maximum) and following these instructions. Copper that lifts off the board should be cemented in place with a quick drying acetate base cement having good electrical insulating properties.

A break in the copper should be repaired by soldering a short length of tinned copper wire across the break.

Use only high quality rosin core solder when repairing etched circuit boards. NEVER USE PASTE FLUX. After soldering, clean off any excess flux and coat the repaired area with a high quality electrical varnish or lacquer.

When replacing components with multiple mounting pins such as tube sockets, electrolytic capacitors, and potentiometers, it will be necessary to lift each pin slightly, working around the components several times until it is free.

**WARNING:** If the specific instructions outlined in the steps below regarding etched circuit boards without eyelets are not followed, extensive damage to the etched circuit board will result.

1. Apply heat sparingly to lead of component to be replaced. If lead of component passes through an eyelet in the circuit board, apply heat on component side of board. If lead of component does not pass through an eyelet, apply heat to conductor side of board.

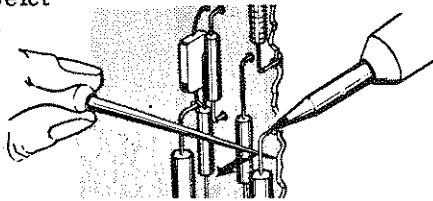

2. Reheat solder in vacant eyelet and quickly insert a small awl to clean inside of hole. If hole does not have an eyelet, insert awl or a #57 drill from conductor side of board.

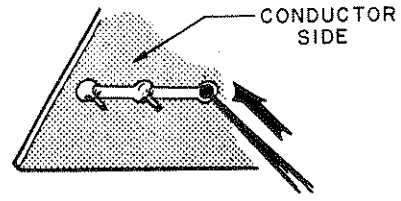

3. Bend clean tinned lead on new part and carefully insert through eyelets or holes in board.



4. Hold part against board (avoid overheating) and solder leads. Apply heat to component leads on correct side of board as explained in step 1.

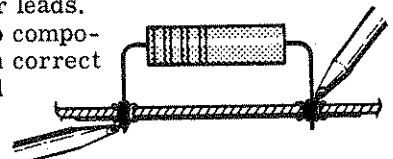

In the event that either the circuit board has been damaged or the conventional method is impractical, use method shown below. This is especially applicable for circuit boards without eyelets.

1. Clip lead as shown below.

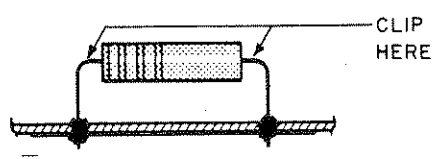

2. Bend protruding leads upward. Bend lead of new component around protruding lead. Apply solder using a pair of long nose pliers as a heat sink.

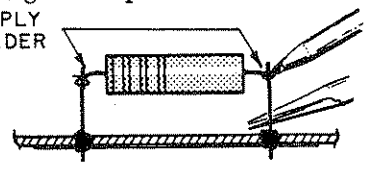

This procedure is used in the field only as an alternate means of repair. It is not used within the factory.

Figure 5-12. Servicing Printed Wiring Boards

Table 5-6. Selected Semiconductor Characteristics

REFERENCE DESIGNATOR	CHARACTERISTICS	Ⓢ PART NO.	SUGGESTED REPLACEMENT
Q7	Power NPN Silicon $h_{fe} = 35$ min. @ $I_c = 4A$ $V_{CE} = 4V$	1854-0225	2N3055 R. C. A.

**5-65 REPAIR AND REPLACEMENT**

5-66 Before servicing a printed wiring board, refer to Figure 5-12. Section VI of this manual contains a tabular list of the instrument's replaceable parts. Before replacing a semiconductor device, refer to Table 5-6 which lists the special characteristics of selected semiconductors. If the device to be replaced is not listed in Table 5-6, the standard manufacturers' part number listed in Section VI is applicable.

**5-67 ADJUSTMENT AND CALIBRATION**

5-68 Adjustment and calibration may be required after performance testing, troubleshooting, or repair and replacement. Perform only those adjustments that affect the operation of the faulty circuit and no others.

**5-69 METER MECHANICAL ZERO**

5-70 Proceed as follows to zero meter:

a. Turn off instrument (after it has reached normal operating temperature) and allow 30 seconds for all capacitors to discharge.

b. Insert sharp pointed object (pen point or awl) into the small hole at top of round black plastic disc located directly below meter face.

c. Rotate plastic disc clockwise (cw) until meter reads zero, then rotate ccw slightly in order to free adjustment screw from meter suspension. If pointer moves, repeat steps b and c.

**5-71 METER CALIBRATION**

5-72 To calibrate the ammeter, proceed as follows:

a. Connect test setup shown on Figure 5-10.

b. Set CURRENT control fully clockwise.

c. Set METER SELECTION switch to mA.

d. Turn on supply and adjust VOLTAGE controls so that differential voltmeter indicates exactly 1.2 Volts.

e. Adjust R52 until front panel ammeter indicates: 6214A, 1A; 6216A, 400mA; 6218A, 200mA.

## SECTION VI REPLACEABLE PARTS

### 6-1 INTRODUCTION

6-2 This section contains information for ordering replacement parts. Table 6-4 lists parts in alpha-numeric order by reference designators and provides the following information:

- a. Reference Designators. Refer to Table 6-1.
- b. Description. Refer to Table 6-2 for abbreviations.
- c. Total Quantity (TQ). Given only the first time the part number is listed except in instruments containing many sub-modular assemblies, in which case the TQ appears the first time the part number is listed in each assembly.
- d. Manufacturer's Part Number or Type.
- e. Manufacturer's Federal Supply Code Number. Refer to Table 6-3 for manufacturer's name and address.
- f. Hewlett-Packard Part Number.
- g. Recommended Spare Parts Quantity (RS) for complete maintenance of one instrument during one year of isolated service.
- h. Parts not identified by a reference designator are listed at the end of Table 6-4 under Mechanical and/or Miscellaneous. The former consists of parts belonging to and grouped by individual assemblies; the latter consists of all parts not immediately associated with an assembly.

### 6-3 ORDERING INFORMATION

6-4 To order a replacement part, address order or inquiry to your local Hewlett-Packard sales office (see lists at rear of this manual for addresses). Specify the following information for each part: Model, complete serial number, and any Option or special modification (J) numbers of the instrument; Hewlett-Packard part number; circuit reference designator; and description. To order a part not listed in Table 6-4, give a complete description of the part, its function, and its location.

Table 6-1. Reference Designators

A = assembly	E = miscellaneous
B = blower (fan)	electronic part
C = capacitor	F = fuse
CB = circuit breaker	J = jack, jumper
CR = diode	K = relay
DS = device, signaling (lamp)	L = inductor
	M = meter

Table 6-1. Reference Designators (Continued)

P = plug	V = vacuum tube, neon bulb, photocell, etc.
Q = transistor	VR = zener diode
R = resistor	X = socket
S = switch	Z = integrated circuit or network
T = transformer	
TB = terminal block	
TS = thermal switch	

Table 6-2. Description Abbreviations

A = ampere	mfr = manufacturer
ac = alternating current	mod. = modular or modified
assy. = assembly	mtg = mounting
bd = board	n = nano = $10^{-9}$
bkt = bracket	NC = normally closed
°C = degree Centigrade	NO = normally open
cd = card	NP = nickel-plated
coef = coefficient	Ω = ohm
comp = composition	obd = order by description
CRT = cathode-ray tube	OD = outside diameter
CT = center-tapped	p = pico = $10^{-12}$
dc = direct current	P.C. = printed circuit
DPDT = double pole, double throw	pot. = potentiometer
DPST = double pole, single throw	p-p = peak-to-peak
elect = electrolytic	ppm = parts per million
encap = encapsulated	pvr = peak reverse voltage
F = farad	rect = rectifier
°F = degree Fahrenheit	rms = root mean square
fxd = fixed	Si = silicon
Ge = germanium	SPDT = single pole, double throw
H = Henry	SPST = single pole, single throw
Hz = Hertz	SS = small signal
IC = integrated circuit	T = slow-blow
ID = inside diameter	tan. = tantalum
incnd = incandescent	Ti = titanium
k = kilo = $10^3$	V = volt
m = milli = $10^{-3}$	var = variable
M = mega = $10^6$	ww = wirewound
μ = micro = $10^{-6}$	W = Watt
met. = metal	

Table 6-3. Code List of Manufacturers

CODE	MANUFACTURER	ADDRESS	CODE	MANUFACTURER	ADDRESS
00629	EBY Sales Co., Inc.	Jamaica, N.Y.	07137	Transistor Electronics Corp.	Minneapolis, Minn.
00656	Aerovox Corp.	New Bedford, Mass.	07138	Westinghouse Electric Corp.	Elmira, N.Y.
00853	Sangamo Electric Co.	Pickens, S.C.	07263	Fairchild Camera and Instrument	Mountain View, Calif.
01121	Allen Bradley Co.	Milwaukee, Wis.	07387	Birtcher Corp., The	Los Angeles, Calif.
01255	Litton Ind.	Beverly Hills, Calif.	07397	Sylvania Electric Prod. Inc.	Mountainview, Calif.
01281	TRW Semiconductors, Inc.	Lawndale, Calif.	07716	IRC Div. of TRW Inc.	Burlington, Iowa
01295	Texas Instruments, Inc.	Dallas, Texas	07910	Continental Device Corp.	Hawthorne, Calif.
01686	RCL Electronics, Inc.	Manchester, N.H.	07933	Raytheon Co. Components Div.	Mountain View, Calif.
01930	Amerock Corp.	Rockford, Ill.	08484	Breeze Corporations, Inc.	Union, N.J.
02107	Sparta Mfg. Co.	Dover, Ohio	08530	Reliance Mica Corp.	Brooklyn, N.Y.
02114	Ferrocube Corp.	Saugerties, N.Y.	08717	Sloan Company, The	Sun Valley, Calif.
02606	Fenwal Laboratories	Morton Grove, Ill.	08730	Vemaline Products Co. Inc.	Wyckoff, N.J.
02660	Amphenol Corp.	Broadview, Ill.	08806	General Elect. Co. Minature	Lamp Dept. Cleveland, Ohio
02735	Radio Corp. of America, Solid State and	Somerville, N.J.	08863	Nylomatic Corp.	Norrisville, Pa.
03508	G.E. Semiconductor Products Dept.	Syracuse, N.Y.	08919	RCH Supply Co.	Vernon, Calif.
03797	Eldema Corp.	Compton, Calif.	09021	Airco Speer Electronic Components	Bradford, Pa.
03877	Transitron Electronic Corp.	Wakefield, Mass.	09182	*Hewlett-Packard Co. New Jersey Div.	Rockaway, N.J.
03888	Pyrofilm Resistor Co., Inc.	Cedar Knolls, N.J.	09213	General Elect. Co. Semiconductor	Prod. Dept. Buffalo, N.Y.
04009	Arrow, Hart and Hegeman Electric Co.	Hartford, Conn.	09214	General Elect. Co. Semiconductor	Prod. Dept. Auburn, N.Y.
04072	ADC Electronics, Inc.	Harbor City, Calif.	09353	C & K Components Inc.	Newton, Mass.
04213	Caddell & Burns Mfg. Co. Inc.	Mineola, N.Y.	09922	Burndy Corp.	Norwalk, Conn.
04404	*Hewlett-Packard Co. Palo Alto Div.	Palo Alto, Calif.	11115	Wagner Electric Corp.	Tung-Sol Div. Bloomfield, N.J.
04713	Motorola Semiconductor Prod. Inc.	Phoenix, Arizona	11236	CTS of Berne, Inc.	Berne, Ind.
05277	Westinghouse Electric Corp.	Semiconductor Dept. Youngwood, Pa.	11237	Chicago Telephone of Cal. Inc.	So. Pasadena, Calif.
05347	Ultronix, Inc.	Grand Junction, Colo.	11502	IRC Div. of TRW Inc.	Boone, N.C.
05820	Wakefield Engr. Inc.	Wakefield, Mass.	11711	General Instrument Corp.	Newark, N.J.
06001	General Elect. Co. Electronic	Capacitor & Battery Dept. Irmo, S.C.	12136	Philadelphia Handle Co.	Camden, N.J.
06004	Bassik Div. Stewart-Warner Corp.	Bridgeport, Conn.	12615	U.S. Terminals, Inc.	Cincinnati, Ohio
06486	IRC Div. of TRW Inc.	Semiconductor Plant Lynn, Mass.	12617	Hamlin Inc.	Lake Mills, Wisconsin
06540	Amatom Electronic Hardware Co. Inc.	New Rochelle, N.Y.	12697	Clarostat Mfg. Co. Inc.	Dover, N.H.
06555	Beede Electrical Instrument Co.	Penacook, N.H.	13103	Thermalloy Co.	Dallas, Texas
06666	General Devices Co.	Indianapolis, Ind.	14493	*Hewlett-Packard Co.	Loveland, Colo.
06751	Semoor Div. Components, Inc.	Phoenix, Arizona	14655	Cornell-Dubilier Electronics Div.	Federal Pacific Electric Co. Newark, N.J.
06776	Robinson Nugent, Inc.	New Albany, N.Y.	14936	General Instrument Corp. Semicon-	ductor Prod. Group Hicksville, N.Y.
06812	Torrington Mfg. Co.	Van Nuys, Calif.	15801	Fenwal Elect.	Framingham, Mass.
			16299	Corning Glass Works	Raleigh, N.C.

\*Use Code 28480 assigned to Hewlett-Packard Co., Palo Alto, California

Table 6-3. Code List of Manufacturers (Continued)

CODE NO.	MANUFACTURER	ADDRESS
16758	Delco Radio Div. of General Motors Corp.	Kokomo, Ind.
17545	Atlantic Semiconductors, Inc.	Asbury Park, N. J.
17803	Fairchild Camera and Instrument Corp Semiconductor Div. Transducer Plant	Mountain View, Calif.
17870	Daven Div. Thomas A. Edison Industries McGraw-Edison Co.	Orange, N. J.
18324	Signetics Corp.	Sunnyvale, Calif.
19315	Bendix Corp. The Navigation and Control Div.	Teterboro, N. J.
19701	Electra/Midland Corp.	Mineral Wells, Texas
21520	Fansteel Metallurgical Corp.	No. Chicago, Ill.
22229	Union Carbide Corp. Electronics Div.	Mountain View, Calif.
22753	UID Electronics Corp.	Hollywood, Fla.
23936	Pamotor, Inc.	Pampa, Texas
24446	General Electric Co.	Schenectady, N. Y.
24455	General Electric Co. Lamp Div. of Con- sumer Prod. Group	Nela Park, Cleveland, Ohio
24655	General Radio Co.	West Concord, Mass.
24681	LTV Electrosystems Inc Memcor/Com- ponents Operations	Huntington, Ind.
26982	Dynacool Mfg. Co. Inc.	Saugerties, N. Y.
27014	National Semiconductor Corp.	Santa Clara, Calif.
28480	Hewlett-Packard Co.	Palo Alto, Calif.
28520	Heyman Mfg. Co.	Kenilworth, N. J.
28875	IMC Magnetics Corp.	New Hampshire Div. Rochester, N. H.
31514	SAE Advance Packaging, Inc.	Santa Ana, Calif.
31827	Budwig Mfg. Co.	Ramona, Calif.
33173	G. E. Co. Tube Dept.	Owensboro, Ky.
35434	Lectrohm, Inc.	Chicago, Ill.
37942	P. R. Mallory & Co. Inc.	Indianapolis, Ind.
42190	Muter Co.	Chicago, Ill.
43334	New Departure-Hyatt Bearings Div. General Motors Corp.	Sandusky, Ohio
44655	Ohmite Manufacturing Co.	Skokie, Ill.
46384	Penn Engr. and Mfg. Corp.	Doylestown, Pa.
47904	Polaroid Corp.	Cambridge, Mass.
49956	Raytheon Co.	Lexington, Mass.
55026	Simpson Electric Co. Div. of American Gage and Machine Co.	Chicago, Ill.
56289	Sprague Electric Co.	North Adams, Mass.
58474	Superior Electric Co.	Bristol, Conn.
58849	Syntron Div. of FMC Corp.	Homer City, Pa.
59730	Thomas and Betts Co.	Philadelphia, Pa.
61637	Union Carbide Corp.	New York, N. Y.
63743	Ward Leonard Electric Co.	Mt. Vernon, N. Y.

CODE NO.	MANUFACTURER	ADDRESS
70563	Amperite Co. Inc.	Union City, N. J.
70901	Beemer Engrg. Co.	Fort Washington, Pa.
70903	Belden Corp.	Chicago, Ill.
71218	Bud Radio, Inc.	Willoughby, Ohio
71279	Cambridge Thermionic Corp.	Cambridge, Mass.
71400	Bussmann Mfg. Div. of McGraw & Edison Co.	St. Louis, Mo.
71450	CTS Corp.	Elkhart, Ind.
71468	I. T. T. Cannon Electric Inc.	Los Angeles, Calif.
71590	Globe-Union Inc.	Milwaukee, Wis.
71700	General Cable Corp. Cornish Wire Co. Div.	Williamstown, Mass.
71707	Coto Coil Co. Inc.	Providence, R. I.
71744	Chicago Miniature Lamp Works	Chicago, Ill.
71785	Cinch Mfg. Co. and Howard B. Jones Div.	Chicago, Ill.
71984	Dow Corning Corp.	Midland, Mich.
72136	Electro Motive Mfg. Co. Inc.	Willimantic, Conn.
72619	Dialight Corp.	Brooklyn, N. Y.
72699	General Instrument Corp.	Newark, N. J.
72765	Drake Mfg. Co.	Harwood Heights, Ill.
72962	Elastic Stop Nut Div. of Amerace Esna Corp.	Union, N. J.
72982	Erie Technological Products Inc.	Erie, Pa.
73096	Hart Mfg. Co.	Hartford, Conn.
73138	Beckman Instruments Inc. Helipot Div.	Fullerton, Calif.
73168	Fenwal, Inc.	Ashland, Mass.
73293	Hughes Aircraft Co. Electron Dynamics Div.	Torrance, Calif.
73445	Amperex Electronic Corp.	Hicksville, N. Y.
73506	Bradley Semiconductor Corp.	New Haven, Conn.
73559	Carling Electric, Inc.	Hartford, Conn.
73734	Federal Screw Products, Inc.	Chicago, Ill.
74193	Heinemann Electric Co.	Trenton, N. J.
74545	Hubbell Harvey Inc.	Bridgeport, Conn.
74868	Amphenol Corp. Amphenol RF Div.	Danbury, Conn.
74970	E. F. Johnson Co.	Waseca, Minn.
75042	IRC Div. of TRW, Inc.	Philadelphia, Pa.
75183	*Howard B. Jones Div. of Cinch Mfg. Corp.	New York, N. Y.
75376	Kurz and Kasch, Inc.	Dayton, Ohio
75382	Kilka Electric Corp.	Mt. Vernon, N. Y.
75915	Littlefuse, Inc.	Des Plaines, Ill.
76381	Minnesota Mining and Mfg. Co.	St. Paul, Minn.
76385	Minor Rubber Co. Inc.	Bloomfield, N. J.
76487	James Millen Mfg. Co. Inc.	Malden, Mass.
76493	J. W. Miller Co.	Compton, Calif.

\*Use Code 71785 assigned to Cinch Mfg. Co., Chicago, Ill.

Table 6-3. Code List of Manufacturers (Continued)

CODE NO.	MANUFACTURER	ADDRESS
76530	Cinch	City of Industry, Calif.
76854	Oak Mfg. Co. Div. of Oak	
	Electro/Netics Corp.	Crystal Lake, Ill.
77068	Bendix Corp., Electrodynamics Div.	
		No. Hollywood, Calif.
77122	Palnut Co.	Mountainside, N. J.
77147	Patton-MacGuyer Co.	Providence, R. I.
77221	Phaostron Instrument and Electronic Co.	
		South Pasadena, Calif.
77252	Philadelphia Steel and Wire Corp.	
		Philadelphia, Pa.
77342	American Machine and Foundry Co.	
	Potter and Brumfield Div.	Princeton, Ind.
77630	TRW Electronic Components Div.	
		Camden, N. J.
77764	Resistance Products Co.	Harrisburg, Pa.
78189	Illinois Tool Works Inc. Shakeproof Div.	
		Elgin, Ill.
78452	Everlock Chicago, Inc.	Chicago, Ill.
78488	Stackpole Carbon Co.	St. Marys, Pa.
78526	Stanwyck Winding Div. San Fernando	
	Electric Mfg. Co. Inc.	Newburgh, N. Y.
78553	Tinnerman Products, Inc.	Cleveland, Ohio
78584	Stewart Stamping Corp.	Yonkers, N. Y.
79136	Waldes Kohinoor, Inc.	L. I. C., N. Y.
79307	Whitehead Metals Inc.	New York, N. Y.
79727	Continental-Wirt Electronics Corp.	
		Philadelphia, Pa.
79963	Zierick Mfg. Co.	Mt. Kisco, N. Y.
80031	Mapco Div. of Sessions Clock Co.	
		Morristown, N. J.
80294	Bourns, Inc.	Riverside, Calif.
81042	Howard Industries Div. of Msl Ind. Inc.	
		Racine, Wisc.
81073	Grayhill, Inc.	La Grange, Ill.
81483	International Rectifier Corp.	
		El Segundo, Calif.
81751	Columbus Electronics Corp.	Yonkers, N. Y.
82099	Goodyear Sundries & Mechanical Co. Inc.	
		New York, N. Y.
82142	Aircó Speer Electronic Components	
		Du Bois, Pa.
82219	Sylvania Electric Products Inc.	
	Electronic Tube Div. Receiving	
	Tube Operations	Emporium, Pa.
82389	Switchcraft, Inc.	Chicago, Ill.
82647	Metals and Controls Inc. Control	
	Products Group	Attleboro, Mass.
82866	Research Products Corp.	Madison, Wis.
82877	Rotron Inc.	Woodstock, N. Y.
82893	Vector Electronic Co.	Glendale, Calif.
83058	Carr Fastener Co.	Cambridge, Mass.
83186	Victory Engineering Corp.	
		Springfield, N. J.
83298	Bendix Corp. Electric Power Div.	
		Eatontown, N. J.
83330	Herman H. Smith, Inc.	Brooklyn, N. Y.
83385	Central Screw Co.	Chicago, Ill.
83501	Gavitt Wire and Cable Div. of	
	Amerace Esna Corp.	Brookfield, Mass.

CODE NO.	MANUFACTURER	ADDRESS
83508	Grant Pulley and Hardware Co.	
		West Nyack, N. Y.
83594	Burroughs Corp. Electronic	
	Components Div.	Plainfield, N. J.
83835	U. S. Radium Corp.	Morristown, N. J.
83877	Yardeny Laboratories, Inc.	
		New York, N. Y.
84171	Arco Electronics, Inc.	Great Neck, N. Y.
84411	TRW Capacitor Div.	Ogallala, Neb.
86684	RCA Corp. Electronic Components	
		Harrison, N. J.
86838	Rummel Fibre Co.	Newark, N. J.
87034	Marco & Oak Industries a Div. of Oak	
	Electro/netics Corp.	Anaheim, Calif.
87216	Philco Corp. Lansdale Div.	Lansdale, Pa.
87585	Stockwell Rubber Co. Inc.	
		Philadelphia, Pa.
87929	Tower-Olschan Corp.	Bridgeport, Conn.
88140	Cutler-Hammer Inc. Power Distribution	
	and Control Div. Lincoln Plant	
		Lincoln, Ill.
88245	Litton Precision Products Inc, USECO	
	Div. Litton Industries	Van Nuys, Calif.
90634	Gulton Industries Inc.	Metuchen, N. J.
90763	United-Car Inc.	Chicago, Ill.
91345	Miller Dial and Nameplate Co.	
		El Monte, Calif.
91418	Radio Materials Co.	Chicago, Ill.
91506	Augat, Inc.	Attleboro, Mass.
91637	Dale Electronics, Inc.	Columbus, Neb.
91662	Elco Corp.	Willow Grove, Pa.
91929	Honeywell Inc. Div. Micro Switch	
		Freeport, Ill.
92825	Whitso, Inc.	Schiller Pk., Ill.
93332	Sylvania Electric Prod. Inc. Semi-	
	conductor Prod. Div.	Woburn, Mass.
93410	Essex Wire Corp. Stemco	
	Controls Div.	Mansfield, Ohio
94144	Raytheon Co. Components Div.	
	Ind. Components Oper.	Quincy, Mass.
94154	Wagner Electric Corp.	
	Tung-Sol Div.	Livingston, N. J.
94222	Southco Inc.	Lester, Pa.
95263	Leecraft Mfg. Co. Inc.	L. I. C., N. Y.
95354	Methode Mfg. Co.	Rolling Meadows, Ill.
95712	Bendix Corp. Microwave	
	Devices Div.	Franklin, Ind.
95987	Weckesser Co. Inc.	Chicago, Ill.
96791	Amphenol Corp. Amphenol	
	Controls Div.	Janesville, Wis.
97464	Industrial Retaining Ring Co.	
		Irvington, N. J.
97702	IMC Magnetics Corp. Eastern Div.	
		Westbury, N. Y.
98291	Sealectro Corp.	Mamaroneck, N. Y.
98410	ETC Inc.	Cleveland, Ohio
98978	International Electronic Research Corp.	
		Burbank, Calif.
99934	Renbrandt, Inc.	Boston, Mass.

Table 6-4. Replaceable Parts

REF. DESIG.	DESCRIPTION	TQ	MFR. PART NO.	MFR. CODE	 PART NO.	RS
C1	fxd, elect. 5 $\mu$ f 65Vdc	1		09182	0180-1836	1
C2	fxd, elect. 68 $\mu$ f 15Vdc	1	150D686X0015R2	56289	0180-1835	1
C3	fxd, film .0022 $\mu$ f 200Vdc	1	192P22292	56289	0160-0154	1
C4	fxd, mylar .0047 $\mu$ f 200Vdc	1	192P47292	56289	0160-0157	1
C5	fxd, elect. 100 $\mu$ f 50Vdc	1		09182	0180-1852	1
C6	fxd, mylar .01 $\mu$ f 200Vdc	1		09182	0160-0161	1
C7, 8, 13	NOT ASSIGNED	-	-	-	-	-
C9	fxd, elect. 490 $\mu$ f 85Vdc	1		09182	0180-1888	1
C10-C12	fxd, ceramic .02 $\mu$ f 600Vdc	3	Type ED. 02	72982	0150-0024	1
C14	fxd, elect. 80 $\mu$ f 65Vdc	1		09182	0180-2156	1
CR1, 2	Rect. Si. 250mA 200prv	4	1N485B	93332	1901-0033	4
CR3	Rect. Si. 400mA 10prv	3	1N4828	03508	1901-0461	3
CR4	Rect. Si. 250mA 200prv		1N485B	93332	1901-0033	
CR5, 6	Rect. Si. 400mA 10prv		1N4828	03508	1901-0461	
CR7	Rect. Si. 500mA 200prv	6	1N3253	02735	1901-0389	6
CR8, 9, 12, 17-19	NOT ASSIGNED	-	-	-	-	-
CR10, 11	Rect. Si. 500mA 200prv		1N3253	02735	1901-0389	
CR13	Stabistor 2.4V @ 100mA	1	1N4830	03508	1901-0460	1
CR14-CR16	Rect. Si. 500mA 200prv		1N3253	02735	1901-0389	
CR20	Rect. Si. 250mA 200prv		1N485B	93332	1901-0033	
DS1	Lamp-Neon	1	A1C	03508	2140-0047	1
F1	Fuse Cartridge .5A 250V 3AG	1	312.005	75915	2110-0012	5
M1	Meter Assembly, 0-30V, 0-500mA	1		09182	1120-1137	1
Q1, 2	SS NPN Si.	4	2N3391	03508	1854-0071	4
Q3, 4	SS PNP Si.	3	2N2907A	56289	1853-0099	3
Q5	SS PNP Si.	1	40362	02735	1853-0041	1
Q6, 8, 10	NOT ASSIGNED	-	-	-	-	-
Q7	Power NPN Si.	1		09182	1854-0225	1
Q9	SS NPN Si.	1	2N3417	03508	1854-0087	1
Q11	SS PNP Si.		2N2907A	56289	1853-0099	
Q12, 13	SS NPN Si.		2N3391	03508	1854-0071	
R1	fxd, ww 1K $\Omega$ $\pm$ 5% 3W	1	242E1025	56289	0813-0001	1
R2-5, 7, 9, 13, 15, 16, 23, 27, 29, 34-39, 41, 44-47, 49, 50, 58-60, 62	NOT ASSIGNED	-	-	-	-	-
R6	fxd, met. film 1.5K $\Omega$ $\pm$ 1% 1/8W	2	Type CEA T-O	07716	0757-0427	1
R8	fxd, comp 24 $\Omega$ $\pm$ 5% 1/2 W	1	EB-2405	01121	0686-2405	1
R10	var, ww DUAL 5K $\Omega$ -50 $\Omega$ $\pm$ 5%	1		09182	2100-2526	1
R11	var. ww DUAL 10K $\Omega$ -100 $\Omega$ $\pm$ 5%	1		09182	2100-2527	1
R12	fxd, ww 1.2K $\Omega$ $\pm$ 5% 3W	1	242E1225	56289	0811-1208	1
R14	fxd, comp 3.3 $\Omega$ $\pm$ 5% 1/2 W	1	EB-0335	01121	0686-0335	1
R17	fxd, comp 12K $\Omega$ $\pm$ 5% 1/2 W	1	EB-1235	01121	0686-1235	1
R18	fxd, comp 6.2K $\Omega$ $\pm$ 5% 1/2 W	1	EB-6225	01121	0686-6225	1
R19	fxd, comp 1K $\Omega$ $\pm$ 5% 1/2 W	3	EB-1025	01121	0686-1025	1
R20	fxd, met. ox. 2K $\Omega$ $\pm$ 5% 2W	1	Type C42S	16299	0764-0025	1
R21	fxd, comp 240 $\Omega$ $\pm$ 5% 1/2 W	1	EB-2415	01121	0686-2415	1
R22	fxd, comp 30K $\Omega$ $\pm$ 5% 1/2 W	1	EB-3035	01121	0686-3035	1
R24	fxd, comp 3.6K $\Omega$ $\pm$ 5% 1W	1	GB-3625	01121	0689-3625	1
R25	fxd, comp 510 $\Omega$ $\pm$ 5% 1/2 W	1	EB-5115	01121	0686-5115	1
R26	fxd, comp 200 $\Omega$ $\pm$ 5% 1/2 W	1	EB-2015	01121	0686-2015	1



REF. DESIG.	DESCRIPTION	TQ	MFR. PART NO.	MFR. CODE	 PART NO.	RS
R28	fxd, comp 680 $\Omega$ $\pm$ 5% $\frac{1}{2}$ W	1	EB-6815	01121	0686-6815	1
R30	fxd, comp 1.8K $\Omega$ $\pm$ 5% $\frac{1}{2}$ W	1	EB-1825	01121	0686-1825	1
R31	fxd, comp 1K $\Omega$ $\pm$ 5% $\frac{1}{2}$ W		EB-1025	01121	0686-1025	
R32	fxd, met. ox. 3K $\Omega$ $\pm$ 5% 2W	1	Type C42S	16299	0698-3642	1
R33	fxd, ww 3 $\Omega$ $\pm$ 0.5% 3W 20ppm	1	Type T-3	01686	0811-1986	1
R40	fxd, comp 47K $\Omega$ $\pm$ 5% $\frac{1}{2}$ W	1	EB-4735	01121	0686-4735	1
R42	fxd, met. film 47.5K $\Omega$ $\pm$ 1% 1/8W	1	Type CEA T-O	07716	0757-0457	1
R43	fxd, met. film 1.5K $\Omega$ $\pm$ 1% 1/8W		Type CEA T-O	07716	0757-0427	
R48	fxd, met. film 1K $\Omega$ $\pm$ 1% 1/8W	1	Type CEA T-O	07716	0757-0280	1
R51	fxd, met. film 42.2 $\Omega$ $\pm$ 1% 1/8W	1	Type CEA T-O	07716	0757-0316	1
R52	var. ww 250 $\Omega$ $\pm$ 20%	1	Type 110-F4	11236	2100-0439	1
R53	fxd, met. film 1.21K $\Omega$ $\pm$ 1% 1/8W	1	Type CEA T-O	07716	0757-0274	1
R54	fxd, met. film 29.9K $\Omega$ $\pm$ 1% $\frac{1}{4}$ W	1	Type CEB T-O	07716	0698-5151	1
R55	fxd, met. film 270 $\Omega$ $\pm$ 1% 1/8W	1	Type CEA T-O	07716	0757-0269	1
R57	fxd, met. film 33K $\Omega$ $\pm$ 1% 1/8W	1	Type CEA T-O	07716	0698-5089	1
R61	fxd, comp 1K $\Omega$ $\pm$ 5% $\frac{1}{2}$ W		EB-1025	01121	0686-1025	
S1	Switch, Line Toggle	1	7101	09353	3101-0163	1
S2	Switch, Slide, TPDT	1	XA70421	82389	3101-1363	1
T1	Power Transformer	1		09182	9100-2182	1
VR1	Diode, Zener 12.4V $\pm$ 5% 400mW	1	1N963	04713	1902-3185	1
VR2	Diode, Zener 4.22V $\pm$ 5% 400mW	3	1N749	04713	1902-3070	3
VR3	Diode, Zener 6.2V $\pm$ 5%	2	1N821	06486	1902-0761	2
VR4	Diode, Zener 7.5V $\pm$ 5% 400mW	1		09182	1902-0064	1
VR5	Diode, Zener 4.22V $\pm$ 5% 400mW		1N749	04713	1902-3070	
VR6	Diode, Zener 6.2V $\pm$ 5%		1N821	06486	1902-0761	
VR7	Diode, Zener 6.19V $\pm$ 5% 400mW	1		09182	1902-0049	1
VR8	Diode, Zener 4.22V $\pm$ 5% 400mW		1N749	04713	1902-3070	
	MISCELLANEOUS					
	P. C. Board Assembly, Main (Includes Components)	1		09182	06216-60021	
	P. C. Board, Main (Blank)	1		09182	5020-5757	
	P. C. Board Assembly, Front Panel (Includes Components)	1		09182	06216-60022	
	P. C. Board, Front Panel (Blank)	1		09182	5020-5731	
	5 Way Binding Post, Maroon	1		09182	1510-0040	1
	5 Way Binding Post, Black	2	DF21C	58474	1510-0039	1
	Panel, Front	1		09182	06216-60001	
	Cover, Bottom	1		09182	4040-0051	
	Cover, Top	1		09182	4040-0050	
	Cap, Rear	1		09182	4040-0052	
	Heat Sink	1		09182	5060-6141	1
	Bezel, Meter 1/6 mod.	1		09182	4040-0295	1
	Spring, Meter	4		09182	1460-0256	1
	Line Cord	1	KH-4096	70903	8120-0050	1
	Strain Relief Bushing, Line Cord	1	SR-5P-1	28520	0400-0013	1
	Fuse Holder Assembly	1	342014	75915	1400-0084	1
	Lock Washer, Fuse Holder	1	1224-08	78189	2190-0037	1
	Neoprene Washer, Fuse Holder	1	901-2	75915	1400-0090	1
	Nut, Fuse Holder	1	903-12	75915	2950-0038	1
	Insulator, Mica, Q7	1	734	08530	0340-0174	1
	Insulator, Transistor Pin, Q7	2		09182	0340-0166	2
	Insulator, Transistor Screw, Q7	2		09182	0340-0168	2
	Knob, Red, Inner, Voltage & Current	2		09182	0370-0179	1
	Knob, Black, Outer, Volt. & Cur.	2		09182	0370-0101	1
	Lens, Front Panel	1		09182	1450-0385	1

## SECTION VII CIRCUIT DIAGRAMS

This section contains the circuit diagrams necessary for the operation and maintenance of this power supply. Included are:

a. Component Location Diagram, Figure 7-1, which shows the physical location and reference designator of parts mounted on the printed

wiring board.

b. Schematic Diagram, Figure 7-2, which illustrates the circuitry for the entire power supply. Voltages are given adjacent to test points, identified by encircled numbers on the schematic and printed wiring board.

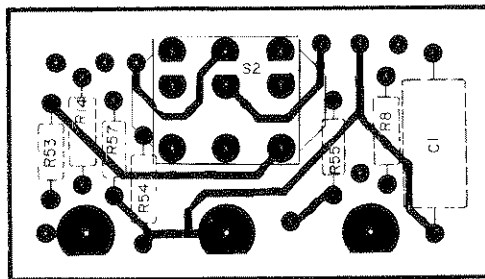
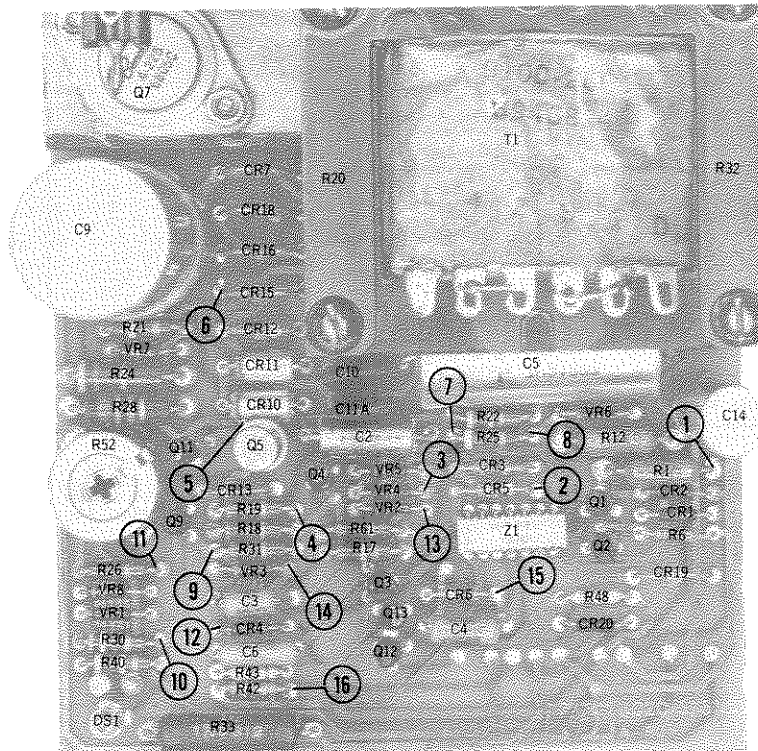

REAR VIEW

Figure 7-1. Model 6216A,  
Component Location Diagram

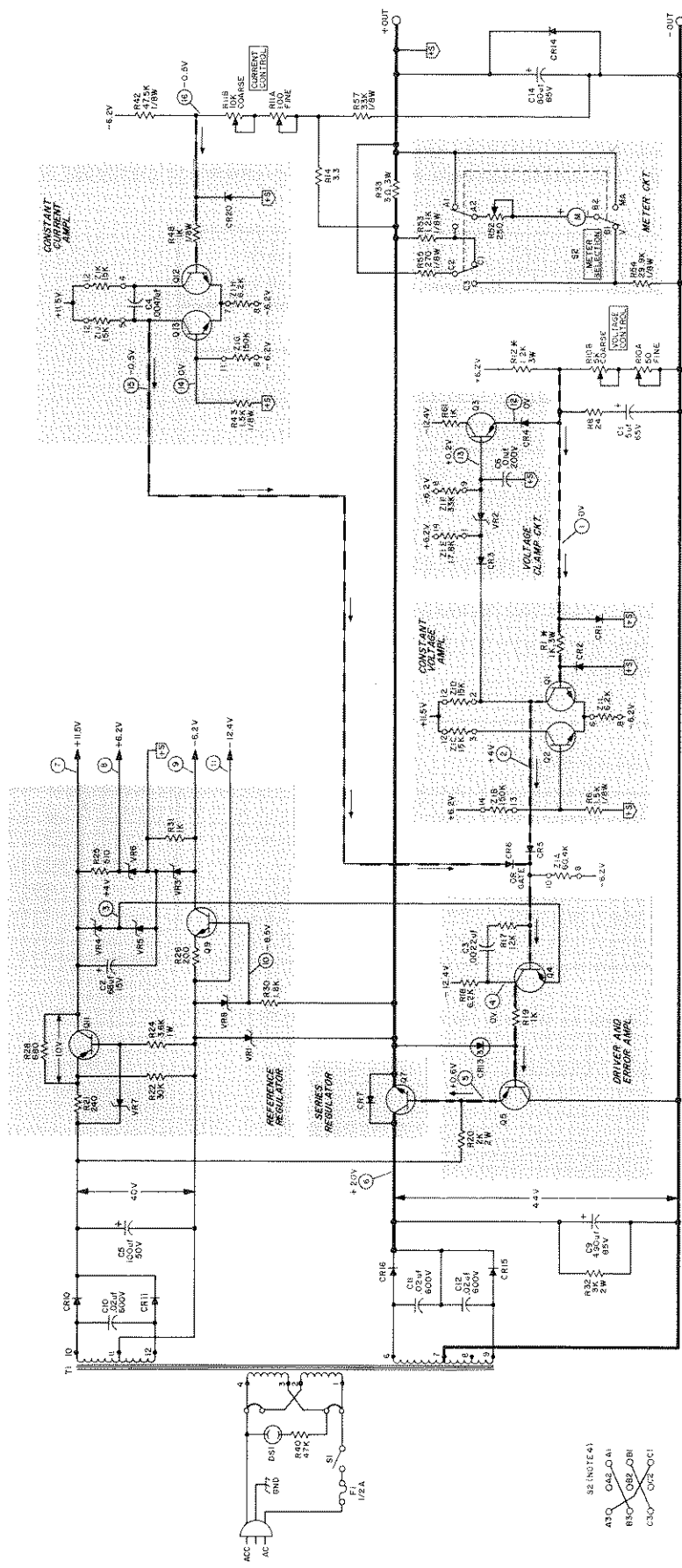

- NOTES:
1. ALL RESISTORS ARE 1/2W, 5% UNLESS OTHERWISE SPECIFIED.
  2. ALL 1/8W AND 1/4WATT RESISTORS ARE 1%, 100PPM.
  3. K DENOTES 50PPM WIRE TEMPERATURE COEFFICIENT.
  4. METER SWITCH IS IN POSITION 1 FOR CONSTANT VOLTAGE POSITION.
  5. METER SWITCH IS IN POSITION 2 FOR CONSTANT CURRENT POSITION.
  6. DENOTES CURRENT FEEDBACK SIGNAL.
  7. DENOTES CURRENT FEEDBACK SIGNAL.
  8. DENOTES CURRENT FEEDBACK SIGNAL.
  9. DENOTES CURRENT FEEDBACK SIGNAL.
  10. DENOTES CURRENT FEEDBACK SIGNAL.
  11. DENOTES CURRENT FEEDBACK SIGNAL.
  12. DENOTES CURRENT FEEDBACK SIGNAL.
  13. DENOTES CURRENT FEEDBACK SIGNAL.
  14. DENOTES CURRENT FEEDBACK SIGNAL.
  15. DENOTES CURRENT FEEDBACK SIGNAL.
  16. DENOTES CURRENT FEEDBACK SIGNAL.
  17. DENOTES CURRENT FEEDBACK SIGNAL.
  18. DENOTES CURRENT FEEDBACK SIGNAL.
  19. DENOTES CURRENT FEEDBACK SIGNAL.
  20. DENOTES CURRENT FEEDBACK SIGNAL.
  21. DENOTES CURRENT FEEDBACK SIGNAL.
  22. DENOTES CURRENT FEEDBACK SIGNAL.
  23. DENOTES CURRENT FEEDBACK SIGNAL.
  24. DENOTES CURRENT FEEDBACK SIGNAL.
  25. DENOTES CURRENT FEEDBACK SIGNAL.
  26. DENOTES CURRENT FEEDBACK SIGNAL.
  27. DENOTES CURRENT FEEDBACK SIGNAL.
  28. DENOTES CURRENT FEEDBACK SIGNAL.
  29. DENOTES CURRENT FEEDBACK SIGNAL.
  30. DENOTES CURRENT FEEDBACK SIGNAL.
  31. DENOTES CURRENT FEEDBACK SIGNAL.
  32. DENOTES CURRENT FEEDBACK SIGNAL.
  33. DENOTES CURRENT FEEDBACK SIGNAL.
  34. DENOTES CURRENT FEEDBACK SIGNAL.
  35. DENOTES CURRENT FEEDBACK SIGNAL.
  36. DENOTES CURRENT FEEDBACK SIGNAL.
  37. DENOTES CURRENT FEEDBACK SIGNAL.
  38. DENOTES CURRENT FEEDBACK SIGNAL.
  39. DENOTES CURRENT FEEDBACK SIGNAL.
  40. DENOTES CURRENT FEEDBACK SIGNAL.
  41. DENOTES CURRENT FEEDBACK SIGNAL.
  42. DENOTES CURRENT FEEDBACK SIGNAL.
  43. DENOTES CURRENT FEEDBACK SIGNAL.
  44. DENOTES CURRENT FEEDBACK SIGNAL.
  45. DENOTES CURRENT FEEDBACK SIGNAL.
  46. DENOTES CURRENT FEEDBACK SIGNAL.
  47. DENOTES CURRENT FEEDBACK SIGNAL.
  48. DENOTES CURRENT FEEDBACK SIGNAL.
  49. DENOTES CURRENT FEEDBACK SIGNAL.
  50. DENOTES CURRENT FEEDBACK SIGNAL.
  51. DENOTES CURRENT FEEDBACK SIGNAL.
  52. DENOTES CURRENT FEEDBACK SIGNAL.
  53. DENOTES CURRENT FEEDBACK SIGNAL.
  54. DENOTES CURRENT FEEDBACK SIGNAL.
  55. DENOTES CURRENT FEEDBACK SIGNAL.
  56. DENOTES CURRENT FEEDBACK SIGNAL.
  57. DENOTES CURRENT FEEDBACK SIGNAL.
  58. DENOTES CURRENT FEEDBACK SIGNAL.
  59. DENOTES CURRENT FEEDBACK SIGNAL.
  60. DENOTES CURRENT FEEDBACK SIGNAL.
  61. DENOTES CURRENT FEEDBACK SIGNAL.
  62. DENOTES CURRENT FEEDBACK SIGNAL.
  63. DENOTES CURRENT FEEDBACK SIGNAL.
  64. DENOTES CURRENT FEEDBACK SIGNAL.
  65. DENOTES CURRENT FEEDBACK SIGNAL.
  66. DENOTES CURRENT FEEDBACK SIGNAL.
  67. DENOTES CURRENT FEEDBACK SIGNAL.
  68. DENOTES CURRENT FEEDBACK SIGNAL.
  69. DENOTES CURRENT FEEDBACK SIGNAL.
  70. DENOTES CURRENT FEEDBACK SIGNAL.
  71. DENOTES CURRENT FEEDBACK SIGNAL.
  72. DENOTES CURRENT FEEDBACK SIGNAL.
  73. DENOTES CURRENT FEEDBACK SIGNAL.
  74. DENOTES CURRENT FEEDBACK SIGNAL.
  75. DENOTES CURRENT FEEDBACK SIGNAL.
  76. DENOTES CURRENT FEEDBACK SIGNAL.
  77. DENOTES CURRENT FEEDBACK SIGNAL.
  78. DENOTES CURRENT FEEDBACK SIGNAL.
  79. DENOTES CURRENT FEEDBACK SIGNAL.
  80. DENOTES CURRENT FEEDBACK SIGNAL.
  81. DENOTES CURRENT FEEDBACK SIGNAL.
  82. DENOTES CURRENT FEEDBACK SIGNAL.
  83. DENOTES CURRENT FEEDBACK SIGNAL.
  84. DENOTES CURRENT FEEDBACK SIGNAL.
  85. DENOTES CURRENT FEEDBACK SIGNAL.
  86. DENOTES CURRENT FEEDBACK SIGNAL.
  87. DENOTES CURRENT FEEDBACK SIGNAL.
  88. DENOTES CURRENT FEEDBACK SIGNAL.
  89. DENOTES CURRENT FEEDBACK SIGNAL.
  90. DENOTES CURRENT FEEDBACK SIGNAL.
  91. DENOTES CURRENT FEEDBACK SIGNAL.
  92. DENOTES CURRENT FEEDBACK SIGNAL.
  93. DENOTES CURRENT FEEDBACK SIGNAL.
  94. DENOTES CURRENT FEEDBACK SIGNAL.
  95. DENOTES CURRENT FEEDBACK SIGNAL.
  96. DENOTES CURRENT FEEDBACK SIGNAL.
  97. DENOTES CURRENT FEEDBACK SIGNAL.
  98. DENOTES CURRENT FEEDBACK SIGNAL.
  99. DENOTES CURRENT FEEDBACK SIGNAL.
  100. DENOTES CURRENT FEEDBACK SIGNAL.

Figure 7-2. Model 6216A, Schematic Diagram

## APPENDIX A MANUAL BACKDATING CHANGES

Manual backdating changes describe changes necessary to adapt this manual to earlier instruments. To adapt the manual to serial numbers prior to 8M1601, inspect the following table for your serial number and then make the appropriate changes. For serial numbers 8M1151 and up check for inclusion of change sheet.

SERIAL		MAKE CHANGES
Prefix	Number	
8H	1151 - 1600	1
8H	0851 - 1150	1, 2
8C	0301 - 0850	1, 2, 3
7L	0101 - 0300	1, 2, 3, 4

CHANGE 1: Change the component location diagram as shown in Figure A-1.

In Table 6-4, Replaceable Parts List, make the following changes:

Add: R51                    fxd, met. film  $42.2\Omega \pm 1\%$  1/8W            Type CEA T-O            07716    0757-0316  
 Replace Z1 with the following resistors:

REF. DESIG.	DESCRIPTION	MFR. PART NO.	MFR. CODE	 PART NO.
R2, 44	fxd, met. film $6.2K\Omega \pm 1\%$ 1/8W	Type CEA T-O	07716	0698-5087
R3, 4, 46, 47	fxd, met. film $15K\Omega \pm 1\%$ 1/8W	Type CEA T-O	07716	0757-0446
R5, 41	fxd, comp $150K\Omega \pm 5\%$ $\frac{1}{2}$ W	EB-1545	01121	0686-1545
R34	fxd, met. film $60.4K\Omega \pm 1\%$ 1/8W	Type CEA T-O	07716	0698-3572
R60	fxd, met. film $33K\Omega \pm 1\%$ 1/8W	Type CEA T-O	07716	0698-5089
R62	fxd, met. film $17.8K\Omega \pm 1\%$ $\frac{1}{4}$ W	Type CEB T-O	07716	0698-4722

Change: Printed Circuit Board, Blank to 09182,  Part No. 5020-5730.

On the schematic, make the following changes:

- Z1A - replace with R34
- Z1B - replace with R5
- Z1C - replace with R4
- Z1D - replace with R3
- Z1E - replace with R62
- Z1F - replace with R60
- Z1G - replace with R41
- Z1H - replace with R44
- Z1J - replace with R46
- Z1K - replace with R47
- Z1L - replace with R2

Connect R51 in series with R52 between R52 and meter.

CHANGE 2: In Table 6-4, Replaceable Parts List, make the following change:

Change C4 to fxd, mylar .001 $\mu$ f 200Vdc, 09182,  Part No. 0160-0153.

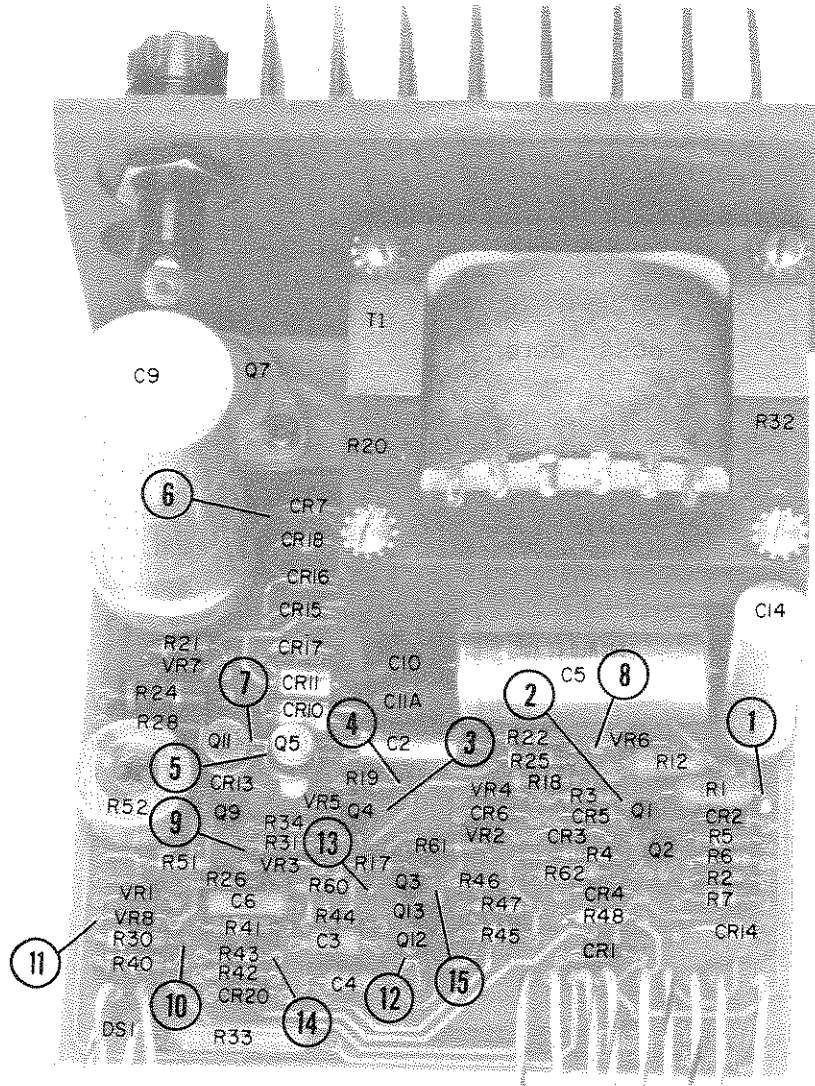



Figure A-1. Model 6216A, Components Location Diagram

CHANGE 3: In Table 6-4, Replaceable Parts List, make the following changes:

REF. DESIG.		DESCRIPTION	MFR. PART NO.	MFR. CODE	 PART NO.
C2	Delete	-	-	-	-
C4	Change to	fxd, mica 390 $\mu$ mf 500Vdc	RCM15E391J	04062	0140-0037
Q11	Change to	SS PNP Si.	40362	02735	1853-0041
R4,47	Change to	fxd, met. film 23K $\Omega$ $\pm$ 1% 1/8W	Type CEA T-O	07716	0698-3269
R5,41	Change to	fxd, comp 360K $\Omega$ $\pm$ 5% $\frac{1}{2}$ W	EB-3645	01121	0686-3645
R7,45	Add	fxd, comp 560K $\Omega$ $\pm$ 5% $\frac{1}{2}$ W	EB-5645	01121	0686-5645
R16	Add	fxd, comp 4.7K $\Omega$ $\pm$ 5% $\frac{1}{2}$ W	EB-4725	01121	0686-4725
R17	Change to	fxd, comp 9.1K $\Omega$ $\pm$ 5% $\frac{1}{2}$ W	EB-9125	01121	0686-9125
R18	Change to	fxd, comp 12K $\Omega$ $\pm$ 5% $\frac{1}{2}$ W	EB-1235	01121	0686-1235
R28	Delete	-	-	-	-
R50	Add	Thermistor 64 $\Omega$ $\pm$ 10%	LB16J1	02606	0837-0023
S2	Change to	Switch, Slide TPDT	11L-1021	82389	3101-1305

CHANGE 3: (Continued)

REF. DESIG.		DESCRIPTION	MFR. PART NO.	MFR. CODE	Ⓢ PART NO.
VR4	Change to Change to Change to Delete	Zener 12.4V ±5% 400mW Main P.C. Board Assembly Main P.C. Board Blank P.C. Board, Front Panel	1N963B  -	04713 09182 09182 -	1902-3185 06216-60021 5020-5730 -

On the schematic, make the following changes:

Change reference voltage at test point 7 from 11.5V to 12.4V and all points that went to +11.5V now go to +12.4V.

Delete R28 (open).

Delete C2 (open).

Add R7, from base of Q2 to reference voltage -6.2V, test point 8.

Add R45, from base of Q13 to reference voltage 12.4V, test point 7.

Add R16, from emitter of Q4 in parallel with VR5 to reference voltage +12.4V, test point 7, change wiring of Q4, VR4, and VR5 as follows: connect VR5 in series with emitter of Q4 to reference voltage +S, and R16 in parallel with VR5 to reference voltage 12.4V. Open lead from emitter of Q4 to VR4. Connect VR4 between VR6 and VR3.

Add R50 in parallel with R51 between the meter and R52.

Change the component location diagram as shown in Figure A-2.

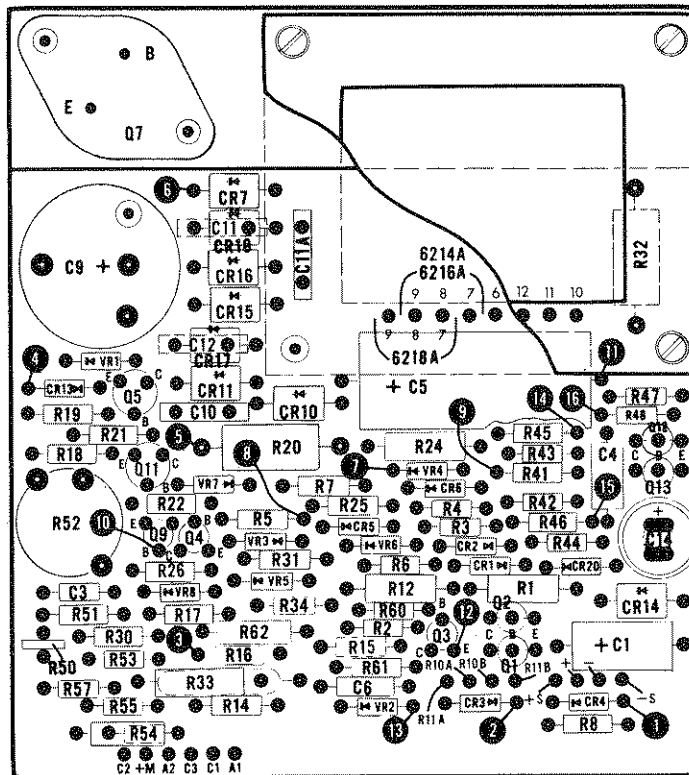

Figure A-2. Model 6216A, Component Location Diagram

CHANGE 4: Change the component location diagram as shown in Figure A-3. Also, change Main P. C. Board Assembly to HP Part No. 06216-60020.

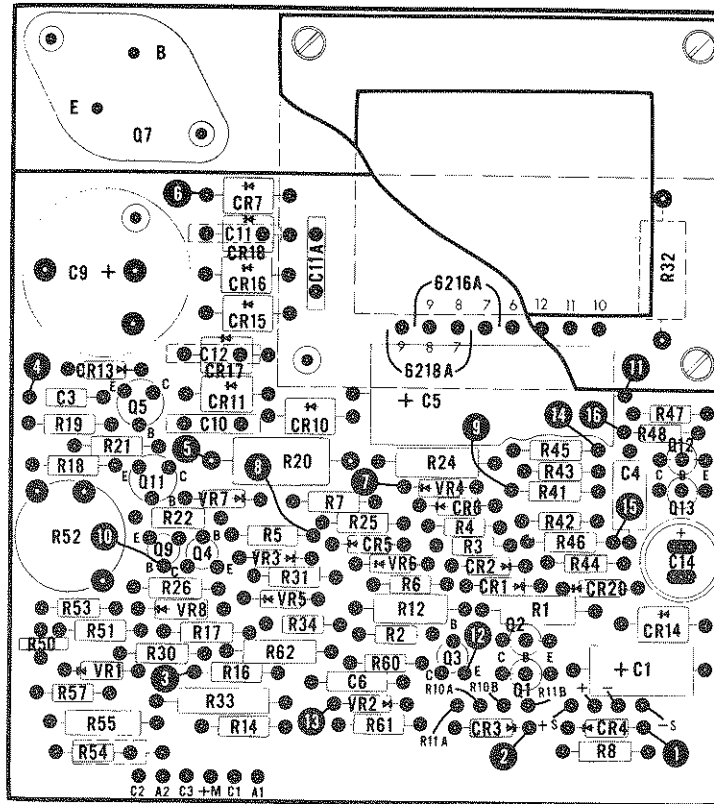

Figure A-3. Model 6216A, Component Location Diagram

MANUAL CHANGES  
 Model 6216A DC Power Supply  
 Manual HP Part No. 06216-90001

Make all corrections in the manual according to errata below, then check the following table for your power supply serial number and enter any listed change(s) in the manual.

SERIAL		MAKE CHANGES
Prefix	Number	
ALL	-	Errata
8M	1751 - 1900	1
9D	1901 - 4600	1, 2
1141A	4601 - 5950	1, 2, 3
1141A	5951 - 6700	1, 2, 3, 4
1141A	6701 - 6850	1 thru 5
1141A	6851 - 7000	1 thru 6
1141A	7001 - up	1 thru 7

ERRATA:

In the replaceable parts table, add the following:  
 Z1: Resistor network (11 fixed resistors, Z1A through Z1L), CTS,  $\text{\textcircled{C}}$  Part No. 1810-0031.  
 On Page 5-9, Figure 5-10, change  $R_L$  from 65 $\Omega$  to 62.5 $\Omega$ .

CHANGE 1:

In the replaceable parts table, make the following change:  
 C14: fixed, elect. 80 $\mu$ f 65Vdc,  $\text{\textcircled{C}}$  Part No. 0180-2258.

NOTE

If board is not equipped to handle all four leads, remove two outer leads attached to can.

CHANGE 2:

In the replaceable parts table, make the following changes:  
 R42: Change to 45K $\Omega$ ,  $\pm$ 1%, 1/8W, I.R.C.,  $\text{\textcircled{C}}$  Part No. 0698-5091.

R12: Change to 1K $\Omega$   $\pm$ 5%, 3W, Sprague,  $\text{\textcircled{C}}$  Part No. 0811-1208.  
 R28: Change to 820 $\Omega$ ,  $\pm$ 5%, 1/2W,  $\text{\textcircled{C}}$  Part No. 0686-8215.

ERRATA:

In Appendix A, the  $\text{\textcircled{C}}$  Part Number for the board shown on Page A-4 is 06216-60020.

In Figure 7-1 change TP11 to opposite side of R26.

ERRATA:

In Figure 7-1 on the apron of the Schematic Diagram, move Test Point 11 to the other end of resistor R26. In Appendix A, under Change 4, add the following:

"Change the HP Part No. of the Main P.C. Board Assembly to 06216-60020.

In Figure 7-1, make the following changes:

CR12: Change "CR12" to "CR17."

CR19: Change "CR19" to "CR14."

Test Point 14: Delete the line to VR3 and add a line to the right side (inboard side) of R43.

On Page 5-3, Paragraph 5-16e; change  $\pm$ 2% to  $\pm$ 4%.

CHANGE 3:

In the replaceable parts table, change power transformer T1 to HP Part No. 9100-2609.

CHANGE 4:

The standard color for this instrument is now olive gray for all external surfaces. Option X95 designates use of the former color scheme of blue gray. New part numbers are shown on back.

DESCRIPTION	HP PART NUMBER	
	STANDARD	OPTION X95
Front Panel	06216-60003	Refer to Manual Parts List
Meter Trim	4040-0934	
Rear Cap (115V Option)	5081-4927	
Rear Cap (230V Option)	5081-4929	
Heat Sink	5020-8425	
Top Cover	4040-0927	
Bottom Cover	4040-0928	



CHANGE 5:

The separate neon lamp, lamp jewel, and resistor have been replaced by a lampholder assembly. In the replaceable parts table: Change the entry under DS1 to "Lampholder Assembly, HP Part No. 1450-0510"; and delete R40 and the DS1 lens. Also change the schematic accordingly. Change the HP Part No. of toggle switch S1 to 3101-1258.

CHANGE 6:

On the schematic and in the parts list, change R17 to 8.2K 1/2W, HP Part No. 0686-8225.

ERRATA:

In the parts list, change the maroon binding post to red, HP Part No. 1510-0103.  
In paragraph 3-17, change the third sentence to read as follows: "The output of each power supply can be set separately."  
Correct the Mfg Part No. of F1 to read "312.500."

In Table 1-1 and paragraph 5-34 change the transient recovery time test conditions to a load current change of 50% of the current rating of the supply. In paragraph 5-39, change step c to read: "... front panel meter indicates one half the maximum rated output current." In Figure 5-7, double the listed values of  $R_L$  to 20 $\Omega$ , 125 $\Omega$ , and 500 $\Omega$ .

CHANGE 7:

Make the following changes to the parts list and the schematic:

Change R17 to 7.5K 1/2W, HP Part No. 0686-7525.

Change C3 to .0068 $\mu$ F 200V, HP Part No. 0160-0159.

Add capacitor C7, (C7 is 100pF 300V, HP Part No. 0160-3070, and is connected between the base and collector of Q2).

Add capacitor C2. (C2 is 3.3 $\mu$ F 50V, HP Part No. 0180-2141. It is part of the front panel assembly and is connected between the (+) and (-) output terminals).

ERRATA:

In Table 1-1 change the INTERNAL IMPEDANCE AS A CONSTANT VOLTAGE SOURCE (Output Impedance) specification to read:

OUTPUT IMPEDANCE (TYPICAL): Approximated by a 20 milliohm resistance in series with a 1 microhenry inductance.

► ERRATA:

Add the following notice to paragraph 1-15: "Effective December 1, 1975, extra manuals may be **obtained** by ordering Option 910 when ordering your instrument. The number of extra manuals depends on the number of Option 910's ordered."

8-17-76



**HEWLETT** **hp** **PACKARD**

**P O W E R   S U P P L I E S**